GESAMTKATALOG
COMPLETE CATALOG



MEDE TECHNIK

INHALTSVERZEICHNIS

Warengruppe ab Seite

AA - MESSER

Skalpellgriffe	6
Amputationsmesser	8

AB - SCHEREN

Chirurgische Scheren	9
Präparierschere	14
Gynäkologische Scheren	17
Feine Präparierscheren	20
Tonsillenscheren	22
Nasenscheren	23
Feine chirurgische Scheren	24
Verbandscheren	25
Gipsscheren	27
Darmscheren	28
Universal Scheren	29
Standard Scheren mit Hartmetall	30
Präparierscheren mit Hartmetall	33

AD - PINZETTEN

Anatomische Pinzetten	39
Feine Pinzetten	40
Cirurgische Pinzetten	43
Fasspinzetten	45
Atraumatische Pinzetten	46
Splitterpinzetten	47
Cilienpinzetten	48
Pinzetten mit Hartmetall	49

AF - NAHT INSTRUMENTE

Nadelhalter	52
Nadelhalter Mit Hartmetall	55
Nahtinstrumente	62
Klammerentferner	62
Unterbindungsnadeln	63
Führungshohlsonden	67

AH - KLEMMEN

Arterienklemmen	70
Ligaturzangen	79
Peritoneumklemmen	80
Gefäßklemmen	81

AI - GEWEBEFASSZANGEN

Gewebefäßzangen	82
-----------------	----

AJ - TUCHKLEMMEN

Tuchklemmen	83
-------------	----

Warengruppe ab Seite

AK - SCHLAUCHKLEMMEN

Schlauchklemmen	84
Rollenschlauchklemmen	85

AL - KORNZANGEN

Kornzangen	86
Kappenzangen mit Standgefäß	89

AM - WUNDHACKEN | SPREIZER

Wundhaken	90
Wundspreizer	116
Bauchdeckenhalter	120

AO - GIPSINSTRUMENTE

Gipsinstrumente	121
-----------------	-----

AP - DERMATOLOGIE | NAGEL

Nagelscheren	122
Nagelzangen	124
Nagelfeile	127
Keyes Hautstanzen	128
Fingerringsägen	129
Instrumente Für Finger & Zehennägel	130

AR - MESSINSTRUMENTE

Meßinstrumente	131
Prüfinstrumente	132

AS - TROKARE | SAUGROHRE

Trokare	133
Saugrohre	136
Haltezangen Für Redonnadeln	140
Redon Führungsnadeln	141
Saugrohre	147

AT - STERILISATION INSTRUMENTE

Sterilisation & Aufbewahrung	149
------------------------------	-----

BC - GYNÄKOLOGIE INSTRUMENTE

Gynäkologie	150
Scheidenspekulas	152
Hegar Dilatatoren	153
Probeexzisionszangen	154
Uterus Löffel	156

CF - LAMINEKTOMIEZANGEN

Laminektomie zangen	157
---------------------	-----

Warengruppe ab Seite

DB - ATRAUMATISCHE GEFÄSSKLEMMEN

Atraumatische Gefäßklemmen 158

FA - OHR INSTRUMENTE

Ohrpinzetten 168

Knochenstanzen 169

FB - HALS | NASE INSTRUMENTE

Nasenspekulas 170

Fomon Raspeln 171

Wundhaken 172

GF - ZUNGEN | WANGENHALTER

Mundsperrern 173

Zungen & Wangenhalter 174

KA - KNOCHEN INSTRUMENTE

Raspatorien Mit Ferozellgriff 175

Knochenheber 177

Knochenfeile 185

Raspeln 185

KB - HÄMMER

Hämmer 186

KC - MEISSEL | OSTEOTOME

Meißel & Osteotome 193

MEDE Spezial Meißel 195

Mini Lexer Meißel mit Griff 196

Lexer Meißel 197

Spezial Hohlmeißel 200

Schwanenhalsmeißel 200

Klingenmeißel 201

Stille Meißel & Osteotome 202

Spongiosa Meißel 203

Hohlmeißel 204

Flachmeißel 205

Smith-Petersen Meißel 206

Osteotome 207

KD - SCHARFE LÖFFEL

Scharfe Löffel 209

KE - HOHLMEISSELZANGEN

Hohlmeißelzangen 213

Knochensplitterzangen 219

Warengruppe

ab Seite

KF - KNOCHENHALTEZANGEN

Knochenhalte­zangen 223

KG - BOHR | SCHRAUBEN INSTRUMENTE

Handbohrfutter 235

Reibahlen 236

Knochenchirurgie 237

Schraubendreher 238

Schraubenmesslehre 241

KH - ORTHOPÄDIE INSTRUMENTE

Drahtspannzangen 242

Flachzangen 243

Drahtfasszangen 247

Extraktionszangen für Drähte 248

Drahtschneidezangen 249

Drahtschneidezange mit Hartmetall 250

Bolzenschneider 255

Kramponzangen Universal 258

Drahtscheren 259

Cerclage Draht / Knochendraht 260

Drähte Meßlehren 261

Biegeinstrumente 262

Drahtsägen 263

Drahtumführungs­nadeln 264

Drahtspanner 266

Bleihände 267

KJ - PLATTENBIEGEINSTRUMENTE

Schränkheber 268

Plattenbiegeinstrumente 269

MH - STERILISATION | AUFBEWAHRUNG

Sterilisation & Aufbewahrung 270

Nadel Sterilisierkästchen 272

NR - DENTAL SAUGROHRE

Saugrohre 273

CONTENTS

Class of Goods from Page

AA - BLADES

Scalpel Handle	6
Amputations Knife	8

AB - SCISSORS

Operating Scissors	9
Dissecting Scissors	14
Gynecological Scissors	17
Fine Dissecting Scissors	20
Tonsil Scissors	22
Nasal Scissors	23
Fine Surgical Scissors	24
Bandage Scissors	25
Plaster-Of-Paris Shears	27
Enterotomy Scissors	28
Universal Bandage Scissors	29
Scissors With TC	30
Dissecting Scissors With TC	33

AD - TWEEZERS

Dressing Forceps	39
Fine Tissue Forceps	40
Tissue Forceps	43
Grasping Forceps	45
Atrauma Vascular Forceps	46
Splinter Forceps	47
Cilia Forceps	48
Dissecting Forceps With TC	49

AF - SUTURE INSTRUMENTS

Needle Holders	52
Needle Holders With TC	55
Suture Instruments	62
Manipulator remover	62
Ligature Needles	63
Ligature Conductors	67

AH - CLAMPS

Hemostatic Forceps	70
Ligature Forceps	79
Peritoneal Clamp Forceps	80
Vessel Clamps	81

AI - TISSUE SEIZING FORCEPS

Tissue Seizing Forceps	82
------------------------	----

AJ - TOWEL CLAMPS

Towel Clamps	83
--------------	----

Class of Goods from Page

AK - TUBING CLAMPS

Tubing Clamps	84
Tubing Clamps	85

AL - DRESSING FORCEPS

Sponge And Dressing Forceps	86
Standing Vesel With Cap	89

AM - RETRACTORS

Retractors	90
Self-Retaining Retractors	116
Abdominal Retractor	120

AO - PLASTER CAST INSTRUMENTS

Plaster Shears	121
Plaster Cast Instruments	121

AP - DERMATOLOGY | NAIL

Nail Scissors	122
Nail Cutters	124
Nail File	127
Deraml Punches	128
Fingerring Saws	129
Instruments Fpr Finger & Toes	130

AR - SCERAL MARKERS

Scleral Markers	131
Diagnostics	132

AS - TROCARS | SUCTION TUBES

Trocars	133
Suction Tubes	136
Guide Needles Forceps	140
Redon Guide Needles	141
Suction Tubes	147

AT - STERILIZATION INSTRUMENTS

Sterilization & Conservation	149
------------------------------	-----

BC - GYNECOLOGY INSTRUMENTS

Gynecology	150
Vaginal Specula	152
Uterine Dilators	153
Cervical Biopsy And Specimen Forceps	154
Uterine Scoops	156

Class of Goods from Page

CF - LAMINECTOMY RONGEUR

Laminectomy Rongeur 157

DB - ATRAUMATISCHE VASCULAR CLAMP

Atraumatic Vascular Clamp 158

FA - EAR INSTRUMENTS

Ear Forceps 168

Bone Cutting Forceps 169

FB - THROAT | NOSE INSTRUMENTS

Nasal Specula 170

Fomon Rasps 171

Retractors 172

GF - TONGUE | LIP RETRACTORS

Mouth Gags 173

Tongue & Lip Retractors 174

KA - BONE INSTRUMENTS

Raspatories With Ferrozell Handle 175

Bone Levers 177

Bone Files 185

Rasps 185

KB - MALLETS

Mallets 186

KC - CHISELS | GOUGES

Chisels & Gouges 193

MEDE Special Chisles 195

Mini Gouges With Handle 196

Osteotomes 197

Osteotomes 200

Gouges 200

Chisels & Gouges 201

Stille Chisels & Gouges 202

Chisles 203

KD - BONE CURETTES

Bone Curettes 209

KE - GOUGE FORCEPS

Bone Rongeurs 213

Bone Cutting Forceps 219

Class of Goods from Page

KF - BONE HOLDING FORCEPS

Bone Holding Forceps 223

KG - DRILLING CHUCKS | SCREWDRIVER

Drilling Chucks 235

Reamers 236

Bone Surgery 237

Screw Driver 238

Measuring Instruments 241

KH ORTHOPEDICS INSTRUMENTS

Wire Twister 242

Flat Nose Pliers 243

Wire Holding Forceps 247

Wire Pullers Forceps 248

Wire Cutters 249

Wire Cutters With TC 250

Pin Cutters 255

Krampon Forceps 258

Wire Cutting Scissors 259

Soft Wires 260

Wires Gauging Tools 261

Bending Instruments 262

Wire Saws 263

Cerclage Instruments 264

Wire Tighening Instruments 266

Lead Hands 267

KJ - BENDING IRONS FOR BONE PLATES

Bending Irons For Bone Plates 268

Forceps For Plattes Bending Press 269

MH - STERILIZATION | CONSERVATION

Sterilization & Conservation 270

NR - DENTAL SUCTION TUBES

Suction Tubes 273

SKALPELLGRIFFE
SCALPEL HANDLE

MANGOS DE BISTUTÍES
MANCHES POUR BISTOURIS
MANICI PER BISTURI

AA



Skalpell
Griff Nr. 3

Skalpell
Griff Nr. 3

AA.200.03

AA.201.03

Skalpell
Griff Nr. 3

Skalpell
Griff Nr. 3SL

AA.204.03

AA.204.33

Skalpell
Griff Nr. 4

Skalpell
Griff Nr. 4

AA.200.04

AA.204.04



Skalpell
Griff Nr. 7

AA.206.07



Skalpell
Griff Nr. 7

AA.206.17



Skalpell
Griff Nr. 8

AA.208.08



Skalpellgriff
für Mikroklingen

AA.208.48

AMPUTATIONSMESSER
AMPUTATIONS KNIFE

COUTEAUX À AMPUTATION
CUCHILLOS PARA AMPUTAZIONE
COLTELLI PER AMPUTAZIONE

AA



Article No.	Cut length
AA.300.13	13,0cm
AA.300.16	16,0cm
AA.300.19	19,0cm
AA.300.22	22,0cm
AA.300.28	28,0cm

Catlin

Article No.	Cut length
AA.306.11	13,0cm
AA.306.16	16,0cm
AA.306.19	19,0cm
AA.306.22	22,0cm

Liston

AA.310.17	17,0cm
-----------	--------

Langenbeck

AA.315.12	12,0cm
-----------	--------

**Phalangenmesser
Phalangenknife**

AA.316.09	9,0cm
-----------	-------



Article No.	Size
AB.100.13	13,0cm
AB.100.14	14,5cm
AB.100.16	16,5cm
AB.100.18	18,5cm

Stumpf / Stumpf

Blunt / Blunt

Smusse / Smusse
 Romas / Romas
 Mousses / Mousses



Article No.	Size
AB.101.13	13,0cm
AB.101.14	14,5cm
AB.101.16	16,5cm
AB.101.18	18,5cm



Article No.	Size
AB.102.13	13,0cm
AB.102.14	14,5cm
AB.102.16	16,5cm
AB.102.18	18,5cm

Spitz/ Stumpf

Sharp / Blunt

Acute / Smusse
 Agudas / Romas
 Pointus / Mousses



Article No.	Size
AB.103.13	13,0cm
AB.103.14	14,5cm
AB.103.16	16,5cm
AB.103.18	18,5cm



Article No.	Size
AB.104.13	13,0cm
AB.104.14	14,5cm
AB.104.16	16,5cm
AB.104.18	18,5cm

Spitz/ Spitz

Sharp / Sharp

Acute / Acute
 Agudas / Agudas
 Pointus / Pointus



Article No.	Size
AB.105.13	13,0cm
AB.105.14	14,5cm
AB.105.16	16,5cm
AB.105.18	18,5cm

CHIRURGISCHE SCHEREN OPERATING SCISSORS

TIJERAS PARA CIRUGIA
CISEAUX À CHIRURGIE
FORBICI PER CHIRURGIA

AB



Chirurgische Schere

Article No.	Size
AB.100.44	14,5cm

Stumpf / Stumpf Blunt / Blunt

Smusse / Smusse
Romas / Romas
Mousses / Mousses



Linkshändler
Left-Handed
Para Zudos
Pour Gauchers
Forbici per mancini



Chirurgische Schere

Article No.	Size
AB.101.44	14,5cm

Spitz/ Stumpf

Sharp / Blunt

Acute / Smusse
Agudas / Romas
Pointus / Mousses



Linkshändler
Left-Handed
Para Zudos
Pour Gauchers
Forbici per mancini



Article No.	Size
AB.103.44	14,5cm



Article No.	Size
AB.102.44	14,5cm

Spitz/ Spitz

Sharp / Sharp

Acute / Acute
Agudas / Agudas
Pointus / Pointus

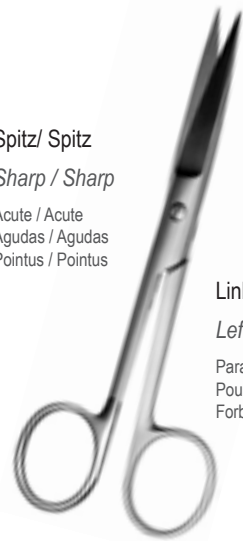

Linkshändler
Left-Handed
Para Zudos
Pour Gauchers
Forbici per mancini



Article No.	Size
AB.105.44	14,5cm



Article No.	Size
AB.104.44	14,5cm



Grazil

Article No.	Size
AB.110.13	13,0cm
AB.110.14	14,5cm

Stumpf / Stumpf

Blunt / Blunt

Smusse / Smusse
Romas / Romas
Mousses / Mousses



Grazil

Article No.	Size
AB.111.13	13,0cm
AB.111.14	14,5cm



Grazil

Article No.	Size
AB.112.13	13,0cm
AB.112.14	14,5cm

Spitz/ Stumpf

Sharp / Blunt

Acute / Smusse
Agudas / Romas
Pointus / Mousses



Grazil

Article No.	Size
AB.113.13	13,0cm
AB.113.14	14,5cm



Grazil

Article No.	Size
AB.114.13	13,0cm
AB.114.14	14,5cm

Spitz/ Spitz

Sharp / Sharp

Acute / Acute
Agudas / Agudas
Pointus / Pointus



Grazil

Article No.	Size
AB.115.13	13,0cm
AB.115.14	14,5cm

CHIRURGISCHE SCHEREN
OPERATING SCISSORS

TIJERAS PARA CIRUGIA
CISEAUX À CHIRURGIE
FORBICI PER CHIRURGIA

AB

gerade
straight



Mayo-Stille Schere



15,0cm
AB.144.15



17,0cm
AB.144.17



19,5cm
AB.144.19

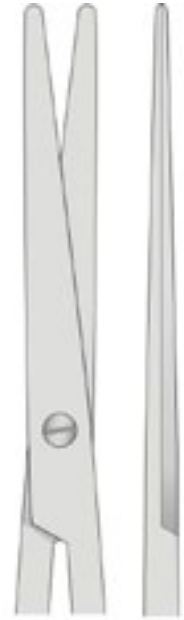

21,0cm
AB.144.21

gebogen
curved



15,0cm
AB.145.15



17,0cm
AB.145.17



19,5cm
AB.145.19

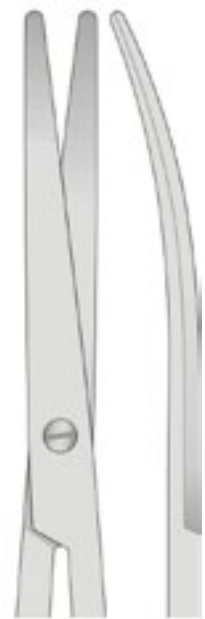

21,0cm
AB.145.21

AB



Sanvenero Schere

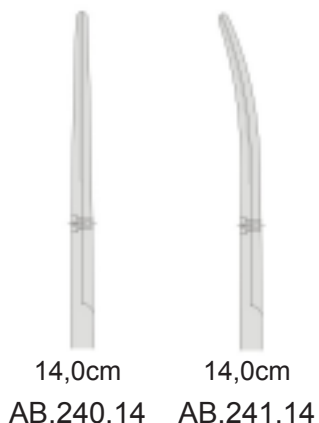

Joseph Schere

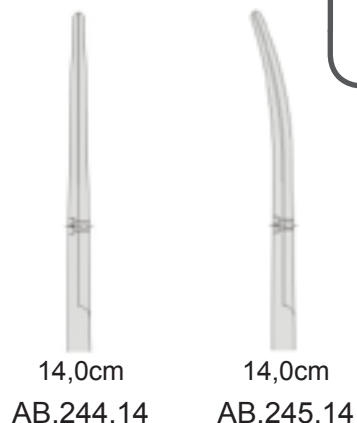

Satinsky Gefäßschere

Article No.	Size
AB.293.24	24,5cm



Strully Schere

Article No.	Size
AB.333.22	22,0cm

PRÄPARIERSCHEREN DISSECTING SCISSORS

TIJERAS PARA PREPARACIONES
CISEAUX À DISSECTION
FOBICI PER DISSEZIONE

AB

Stumpf
Blunt
Smusse
Romas
Mousses



Metzenbaumschere



Article No.	Size
AB.200.14	14,5cm
AB.200.18	18,0cm
AB.200.20	20,0cm
AB.200.23	23,0cm
AB.200.25	25,0cm
AB.200.28	28,0cm
AB.200.30	30,0cm



Article No.	Size
AB.201.14	14,5cm
AB.201.18	18,0cm
AB.201.20	20,0cm
AB.201.23	23,0cm
AB.201.25	25,0cm
AB.201.28	28,0cm
AB.201.30	30,0cm

AB



Lexer Schere



16,0cm
AB.210.16



21,0cm
AB.210.21



16,0cm
AB.211.16



21,0cm
AB.211.21



Lexer - Fino Schere

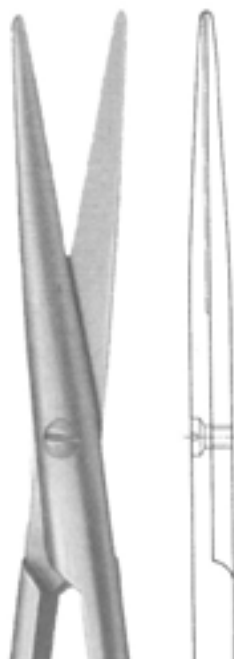

16,0cm
AB.212.16

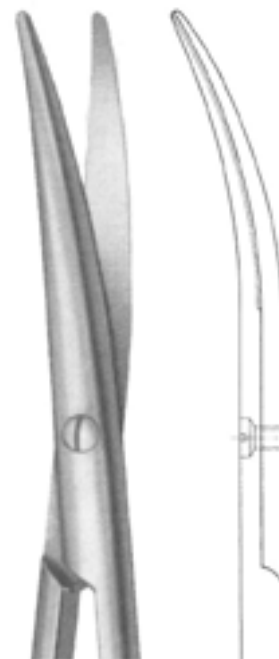

16,0cm
AB.213.16

PRÄPARIERSCHEREN
DISSECTING SCISSORS

TIJERAS PARA PREPARACIONES
CISEAUX À DISSECTION
FOBICI PER DISSEZIONE

AB



Metzenbaum - Lahey
Schere



15,0cm
AB.198.15



15,0cm
AB.199.15



Metzenbaum - Fino
Schere



Article No.	Size
AB.230.14	14,5cm
AB.230.18	18,0cm
AB.230.20	20,0cm
AB.230.23	23,0cm



Article No.	Size
AB.231.14	14,5cm
AB.231.18	18,0cm
AB.231.20	20,0cm
AB.231.23	23,0cm

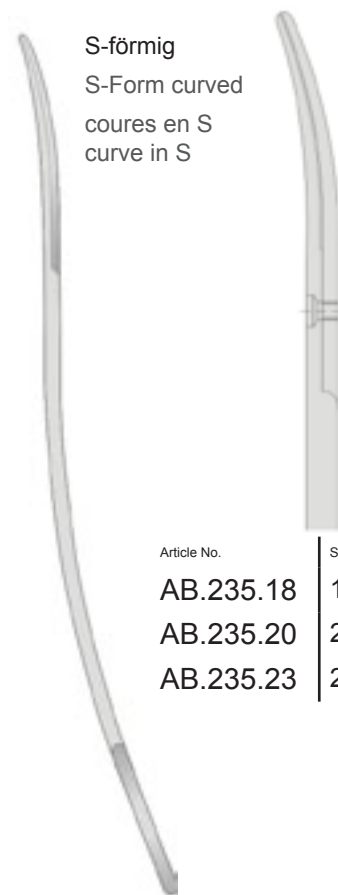

S-förmig
S-Form curved
coures en S
curve in S

Article No.	Size
AB.235.18	18,0cm
AB.235.20	20,0cm
AB.235.23	23,0cm

AB



14,5cm
AB.153.14



19,5cm
AB.153.19



22,5cm
AB.153.22

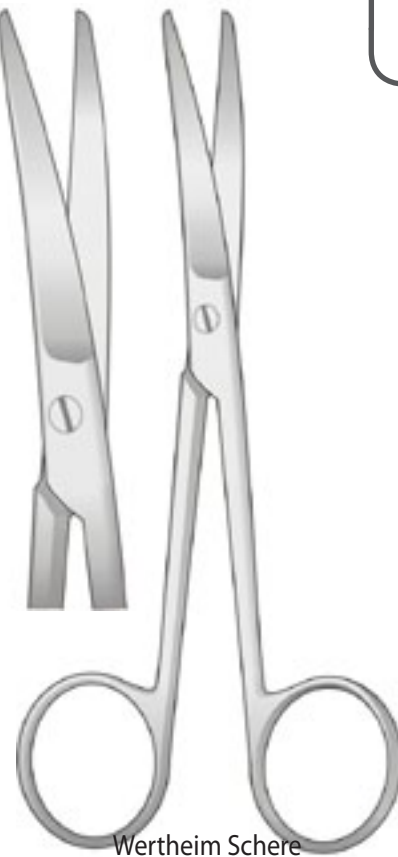

Wertheim Schere



Dubois Schere



27,0cm
AB.154.27



27,0cm
AB.155.27

GYNÄKOLOGISCHE SCHEREN
GYNECOLOGICAL SCISSORS

TIJERAS PARA GINECOLOGIA
CISEAUX À GYNÉCOLOGIE
FOBICI GINECOLOGIA

AB



20,0cm
AB.160.20

Sims



20,0cm
AB.161.20



23,0cm
AB.160.23



23,0cm
AB.161.23



20,0cm
AB.162.20

Sims



20,0cm
AB.163.20



23,0cm
AB.162.23



23,0cm
AB.163.23

AB



Dammschere

Article No.	Size
AB.392.24	24,0cm



18,0cm
 AB.395.18



20,0cm
 AB.397.20



13,0cm
 AB.405.13

16,0cm
 AB.405.16



Braun-Stadler

Article No.	Size
AB.400.22	22,0cm



14,0cm
 AB.400.14

20,0cm
 AB.400.20

FEINE PRÄPARIERSCHEREN
FINE DISSECTING SCISSORS

TIJERAS FINAS PARA PREPARACIONES
 CISEAUX FINS À DISSECTION
 FORBICI FINE PER CHIRURGIA

AB



Kilner



12,0cm
 AB.253.12



15,0cm
 AB.253.15



Goldmann-Fox



12,0cm
 AB.268.12



12,0cm
 AB.269.12



Reynolds



15,0cm
 AB.260.15



15,0cm
 AB.261.15



18,0cm
 AB.260.18



18,0cm
 AB.261.18



Stevens



11,5cm
AB.480.11



11,5cm
AB.481.11



11,5cm
AB.482.11



11,5cm
AB.483.11



Lexer-Baby



10,5cm
AB.484.11



10,5cm
AB.485.11



MEDE Spezial



11,0cm
AB.484.11



11,0cm
AB.485.11

TONSILLENSCHEREN
TONSIL SCISSORS

TIJERAS PARA AMIGDALAS
CISAEUX POUR LES AMYGDALES
FORBICI PER TONSILLE

AB



Schmieden-Taylor

Article No.	Size
AB.337.17	17,0cm

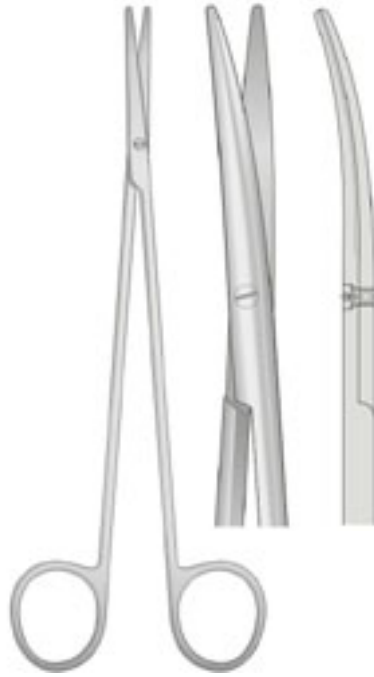

Toennis-Adson

Article No.	Size
AB.339.17	17,5cm



Böttcher

Article No.	Size
AB.352.18	18,0cm



Prince

Article No.	Size
AB.353.17	17,5cm



Good

Article No.	Size
AB.355.19	19,0cm



Oicevrona

Article No.	Size
AB.360.23	23,0cm



Fomon

Article No.	Size
AB.381.15	15,0cm



Cottle

Article No.	Size
AB.383.16	16,0cm



Heyma

Article No.	Size
AB.385.18	18,0cm



Heyma-Knight

Article No.	Size
AB.386.18	17,5cm

FEINE CHIRURGISCHE SCHEREN
FINE SURGICAL SCISSORS

TIJERAS FINAS PARA CIRUGIA
CISEAUX FINS CHIRURGICAUX
FORBICI FINE PER CHIRURGIA

AB



Feine Schere

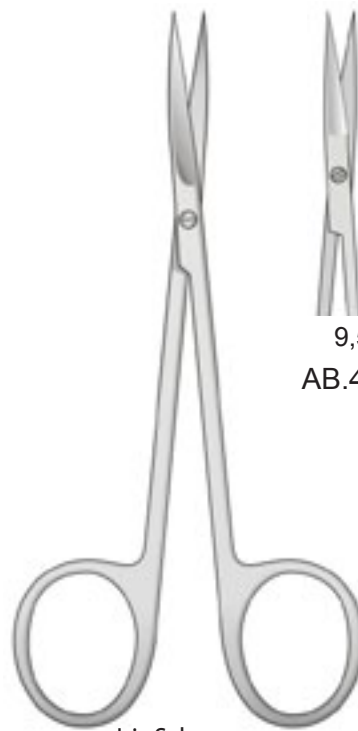
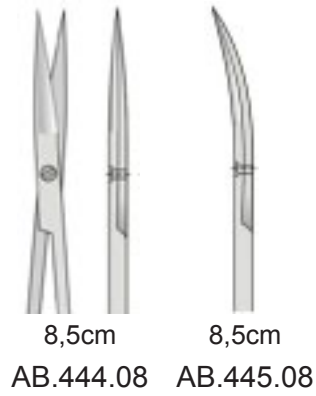

Iris Schere

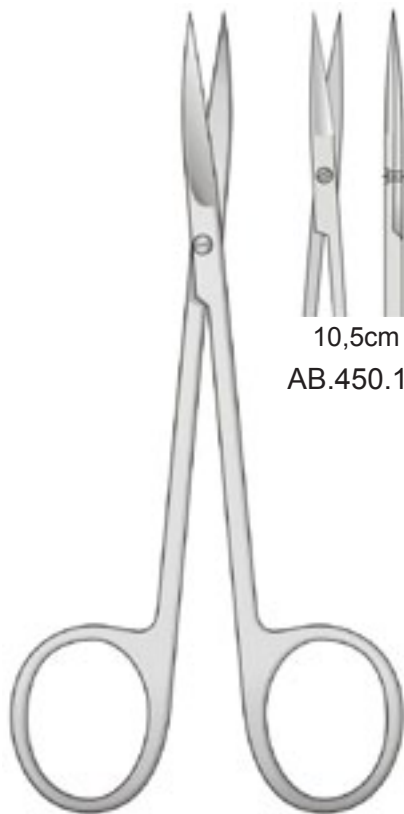
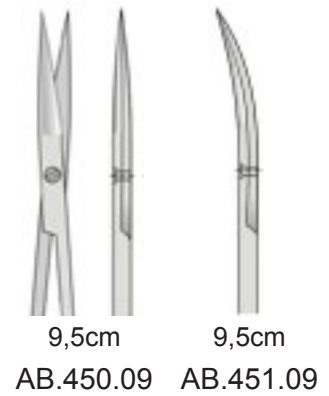

Iris Schere

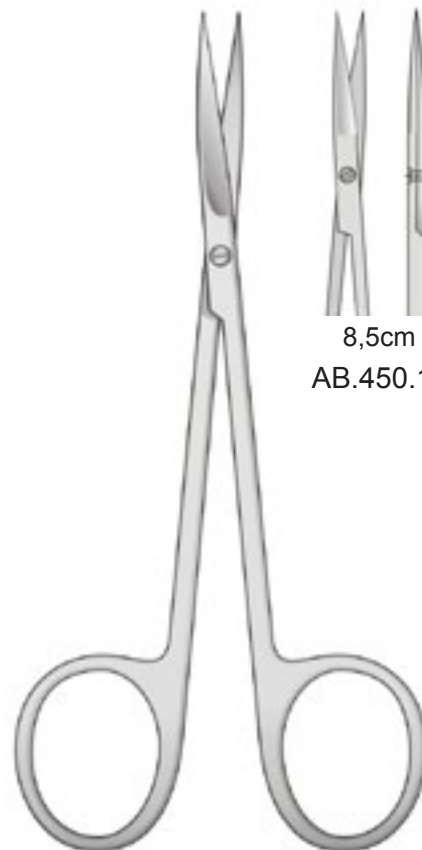
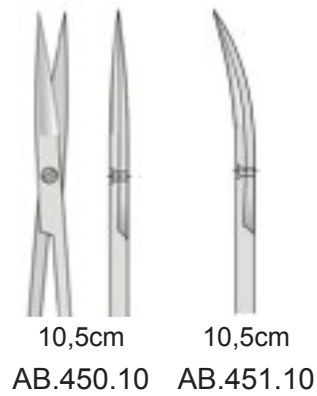

Iris Schere

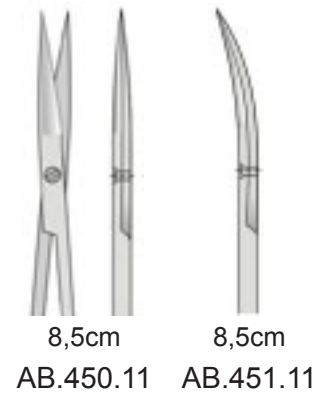



Lister Schere

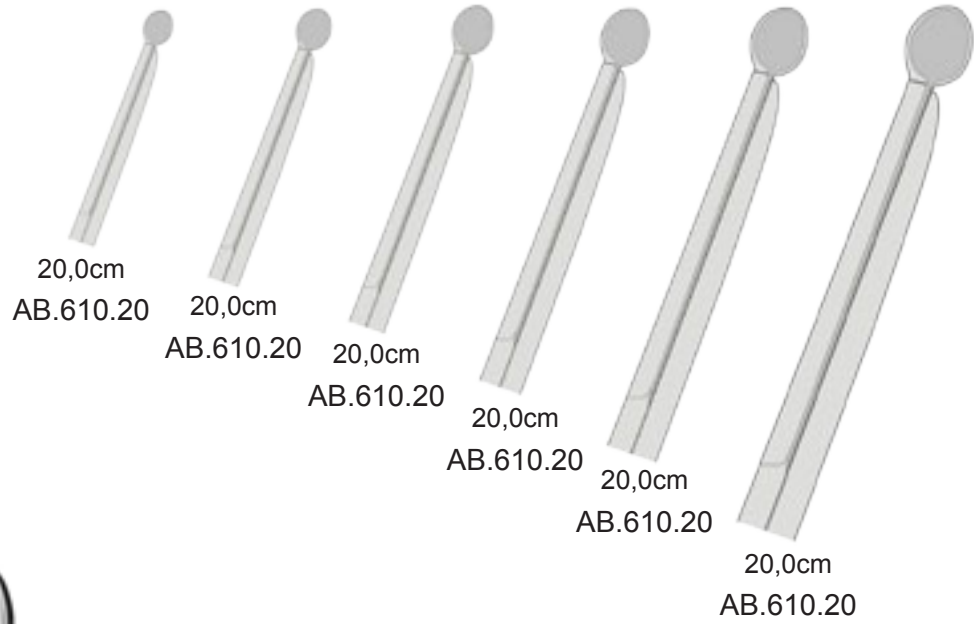

Esmarch

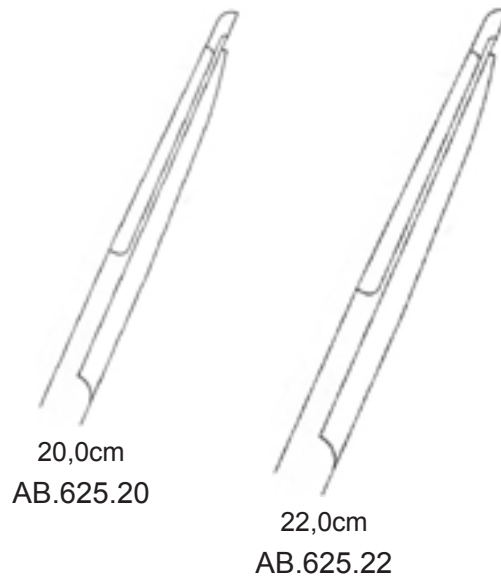

VERBANDSCHEREN
BANDAGE SCISSORS

TIJERAS PARA VENDAJES
CISEAUX POUR PANSEMENTS
FORBICI PER BENDAGGI

AB



Lister Schere



14,5cm
AB.613.14



18,0cm
AB.613.18



20,0cm
AB.613.20

Schere mit Hartmetall
Scissor with Tungsten Carbide
Tijeras con inseraciones tungsten varbit
Ciseaux avec en carbure tungstène
Forbici con carburo di tungsteno



Lister Schere



14,5cm
AB.710.14



18,0cm
AB.710.18



20,0cm
AB.710.20

Mikrotomschliff
Microtom Grinding
Affûtage



Burns



24,0cm
AB.634.24

Glatt
Smooth

Lisas
Lisses
liscie



24,0cm
AB.636.24

Gezahnte Schneide
Blade serrated

Hoja dentada
Lame dentelée
Filo dentallato



24,0cm
AB.895.24

Mit Hartmetallschneide
With Tungsten Carbide

Con inserciones de tungsteno
les mâchoires en tungsténo
Con taglio in carburo di tungsteno

DARMSCHEREN ENTERETOMY SCISSORS

TIJERAS ENTERÓTOMOS
CISEAUX-ENTÉROTOMES
FORBICI PER ENTEROTOMIA

AB

Darmschere
Enterotomy Scissor
Tijeras enterótomos
Ciseaux-entérotomes
Forbici per enterotomia



Darmschere



21,0cm
AB.510.21



21,0cm
AB.514.21



Universal Schere blau

Article No.	Size
AB.657.06	14,0cm



Universal Schere pink

Article No.	Size
AB.657.09	14,0cm



Universal Schwesternschere

Article No.	Size
AB.660.14	14,0cm

Universal Schere
Universal Bandage Scissor
Tijeras para vendajes
Ciseaux pour pansements
Forbici per bendaggi



AB.650.02



AB.650.03



AB.650.04



AB.650.05



Universal Schere

Article No.	Size
AB.650.01	14,0cm



AB.655.02



AB.655.03



AB.655.04



AB.655.05



AB.655.09



Universal Schere

Article No.	Size
AB.655.01	18,0cm

STANDARD SCHEREN MIT HM
SCISSORS WITH TC

TIJARAS CON INSERCIONES CARBURO DE TUNGSTENO
 CISEAUX AVEC PLAQUETTES EN CARBURE DE TUNGSTÈNE
 FORBICI CON TAGLIO IN CARBURO DI TUNGSTENO

AB



Standard



13,0cm
 AB.804.13



14,5cm
 AB.804.14



16,5cm
 AB.804.16



18,5cm
 AB.804.18



Standard



13,0cm
 AB.805.13



14,5cm
 AB.805.14



16,5cm
 AB.805.16

TIJARAS CON INSERCIONES CARBURO DE TUNGSTENO
CISEAUX AVEC PLAQUETTES EN CARBURE DE TUNGSTÈNE
FORBICI CON TAGLIO IN CARBURO DI TUNGSTENO

STANDARD SCHEREN MIT HM SCISSORS WITH TC

AB

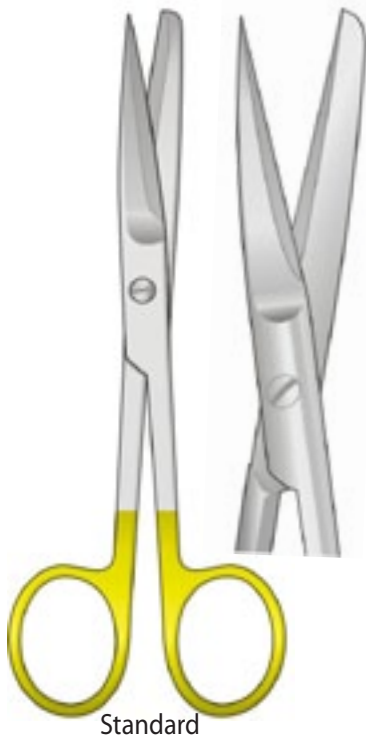

STANDARD SCHEREN MIT HM
SCISSORS WITH TC

TIJARAS CON INSERCIONES CARBURO DE TUNGSTENO
 CISEAUX AVEC PLAQUETTES EN CARBURE DE TUNGSTÈNE
 FORBICI CON TAGLIO IN CARBURO DI TUNGSTENO

AB



Standard



13,0cm
 AB.800.13



14,5cm
 AB.800.14



16,5cm
 AB.800.16



18,5cm
 AB.800.18



Standard

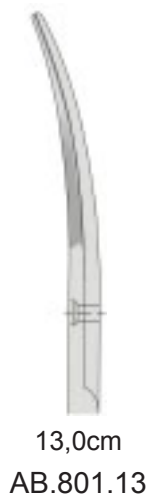

13,0cm
 AB.801.13



14,5cm
 AB.801.14



16,5cm
 AB.801.16

TIJARAS DE DISECCIÓN CON INSERCIONES CARBURO DE TUNGSTENO
 CISEAUX À DISSECTION AVEC PLAQUETTES EN CARBURE DE TUNGSTÈNE
 FORBICI CON TAGLIO IN CARBURO DI TUNGSTENO

PRÄPARIERSCHEREN MIT HM
DISSECTING SCISSORS WITH TC

AB



Mayo



14,5cm
 AB.810.14



17,0cm
 AB.810.17



14,5cm
 AB.811.14



17,0cm
 AB.811.17

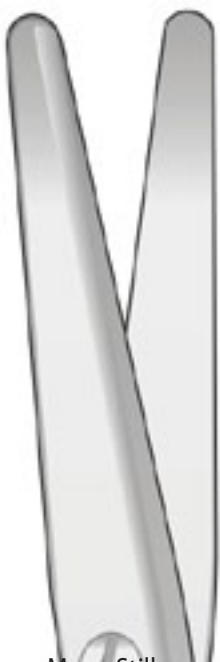

Mayo-Stiller



15,0cm
 AB.816.15



17,0cm
 AB.816.17



15,0cm
 AB.817.15



17,0cm
 AB.817.17

PRÄPARIERSCHEREN MIT HM
DISSECTING SCISSORS WITH TC

TIJARAS DE DISECCIÓN CON INSERCIONES CARBURO DE TUNGSTENO
 CISEAUX À DISSECTION AVEC PLAQUETTES EN CARBURE DE TUNGSTÈNE
 FORBICI CON TAGLIO IN CARBURO DI TUNGSTENO

AB



Metzenbaum



14,0cm
 AB.820.14



14,0cm
 AB.821.14



18,0cm
 AB.820.18

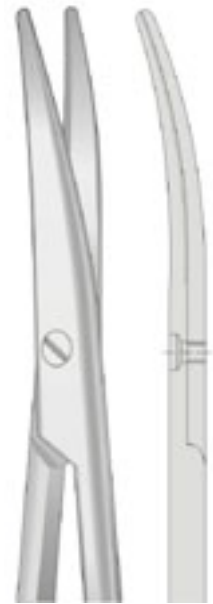

18,0cm
 AB.821.18



20,0cm
 AB.820.20



20,0cm
 AB.821.20



23,0cm
 AB.820.23



23,0cm
 AB.821.23

TIJARAS DE DISECCIÓN CON INSERCIONES CARBURO DE TUNGSTENO
CISEAUX À DISSECTION AVEC PLAQUETTES EN CARBURE DE TUNGSTÈNE
FORBICI CON TAGLIO IN CARBURO DI TUNGSTENO

PRÄPARIERSCHEREN MIT HM DISSECTING SCISSORS WITH TC

AB



25,0cm
AB.820.25

28,0cm
AB.820.28

30,0cm
AB.820.30

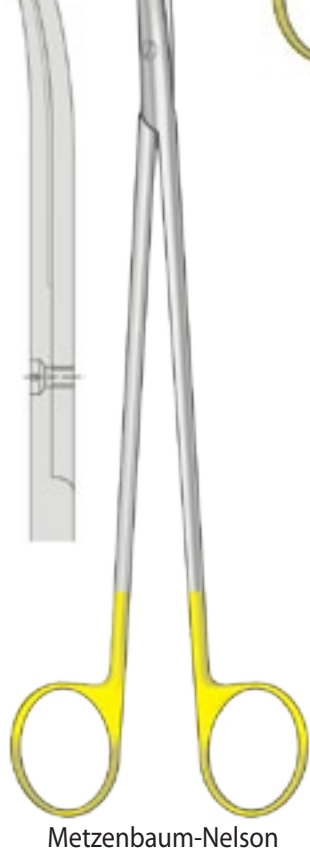

25,0cm
AB.821.25

28,0cm
AB.821.28

30,0cm
AB.821.30

PRÄPARIERSCHEREN MIT HM
DISSECTING SCISSORS WITH TC

TIJARAS DE DISECCIÓN CON INSERCIONES CARBURO DE TUNGSTENO
CISEAUX À DISSECTION AVEC PLAQUETTES EN CARBURE DE TUNGSTÈNE
FORBICI CON TAGLIO IN CARBURO DI TUNGSTENO

AB



Metzenbaum-Fino



14,0cm
AB.822.14



18,0cm
AB.822.18



20,0cm
AB.822.20



23,0cm
AB.822.23



Metzenbaum-Fino



14,0cm
AB.823.14



18,0cm
AB.823.18



20,0cm
AB.823.20



23,0cm
AB.823.23

TIJARAS DE DISECCIÓN CON INSERCIONES CARBURO DE TUNGSTENO
 CISEAUX À DISSECTION AVEC PLAQUETTES EN CARBURE DE TUNGSTÈNE
 FORBICI CON TAGLIO IN CARBURO DI TUNGSTENO

PRÄPARIERSCHEREN MIT HM
DISSECTING SCISSORS WITH TC

AB



PRÄPARIERSCHEREN MIT HM
DISSECTING SCISSORS WITH TC

TIJARAS DE DISECCIÓN CON INSERCIONES CARBURO DE TUNGSTENO
 CISEAUX À DISSECTION AVEC PLAQUETTES EN CARBURE DE TUNGSTÈNE
 FORBICI CON TAGLIO IN CARBURO DI TUNGSTENO

AB



AD

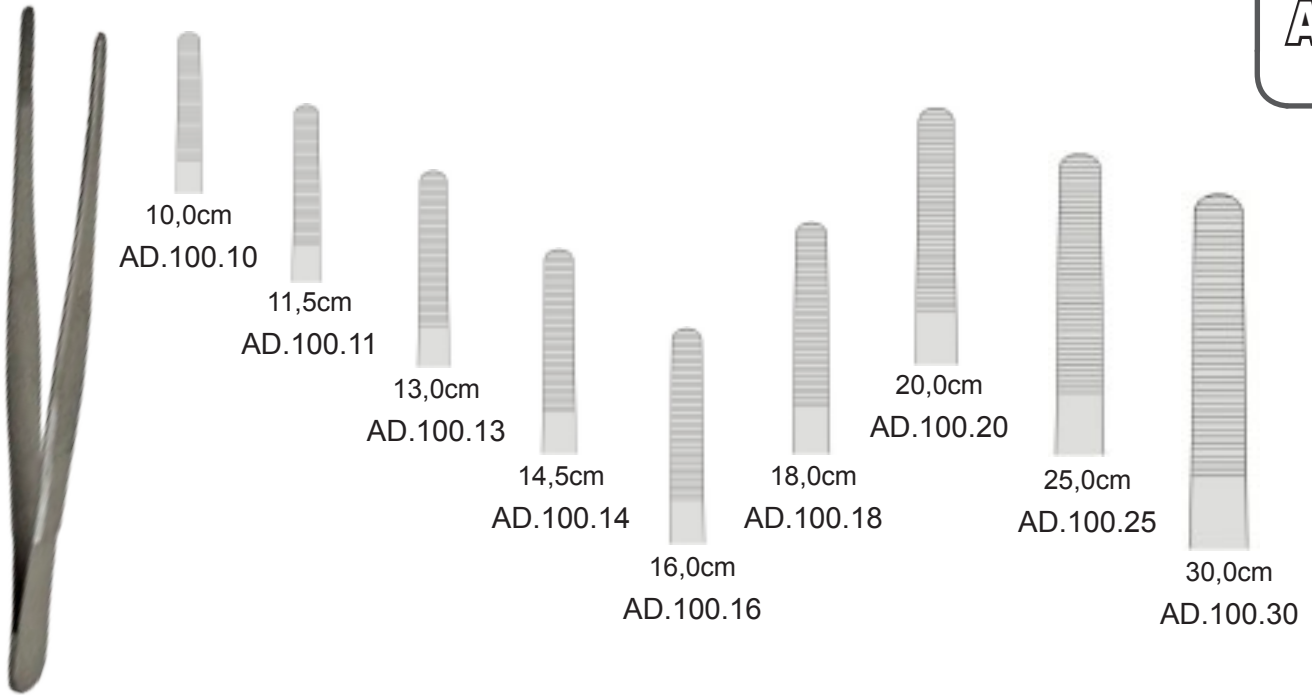

Schmal
 Small
 Pequeno
 Petit
 Piccolo

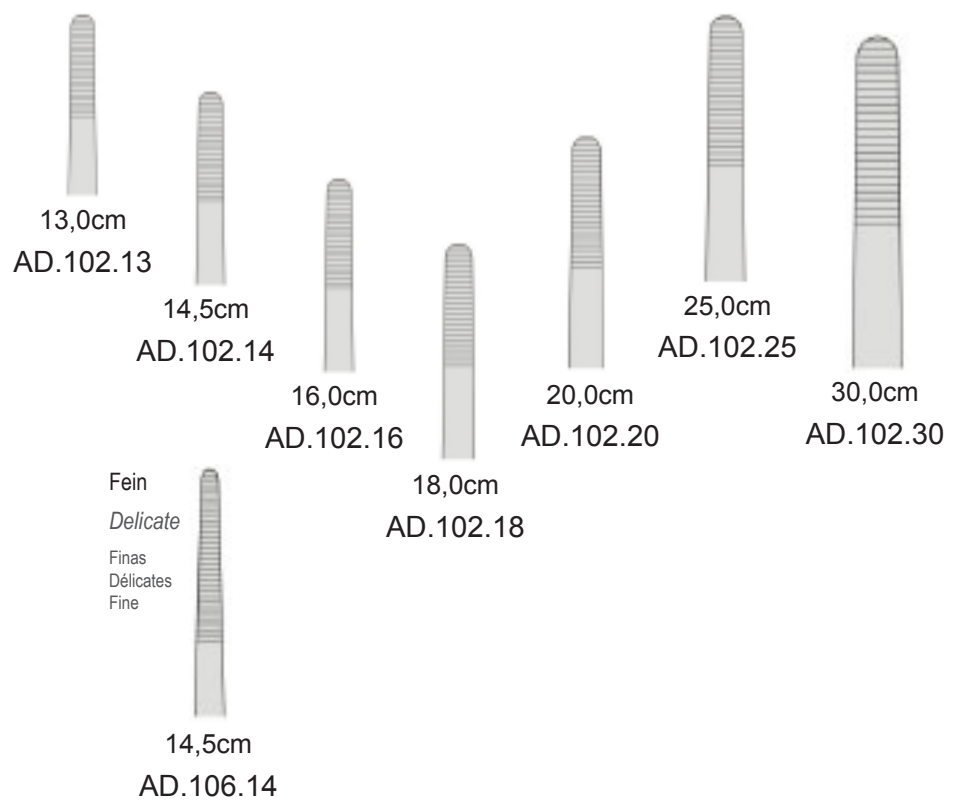

Fein
 Delicate
 Finas
 Délicates
 Fine

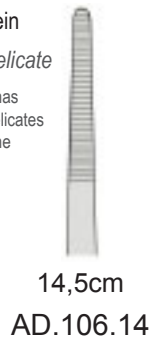

FEINE PINZETTEN
FINE TISSUE FORCEPS

PINZAS DE DISECCIÓN CON DIENTES FINAS
PINCES MODÈLES FINS
PINZE MODELLI FINI

AD



Semken

Article No.	Size
AD.134.12	12,0cm



Semken

Article No.	Size
AD.134.15	15,0cm



Semken

Article No.	Size
AD.135.12	12,0cm



Semken

Article No.	Size
AD.370.12	12,0cm



Semken

Article No.	Size
AD.370.15	15,0cm



Semken

Article No.	Size
AD.371.12	12,0cm

PINZAS DE DISECCIÓN CON DIENTES FINAS
 PINCES MODÈLES FINS
 PINZE MODELLI FINI

FEINE PINZETTEN
FINE TISSUE FORCEPS

AD



Cushing



Potts-Smith



Potts-Smith



FEINE PINZETTEN
FINE TISSUE FORCEPS

PINZAS DE DISECCIÓN CON DIENTES FINAS
PINCES MODÈLES FINS
PINZE MODELLI FINI

AD



Graefe-Iris



10,5cm
AD.260.10



10,5cm
AD.261.10



10,5cm
AD.263.10



Graefe-Iris



10,5cm
AD.264.10



10,5cm
AD.265.10



10,5cm
AD.267.10

PINZAS QUIRÚRGICAS
 PINCES À DISSECTION À GRIFFES
 PINZE CHIRURGICHA A DENTI DI TOPO

CHIRURGISCHE PINZETTEN
TISSUE FORCEPS

AD



Standard

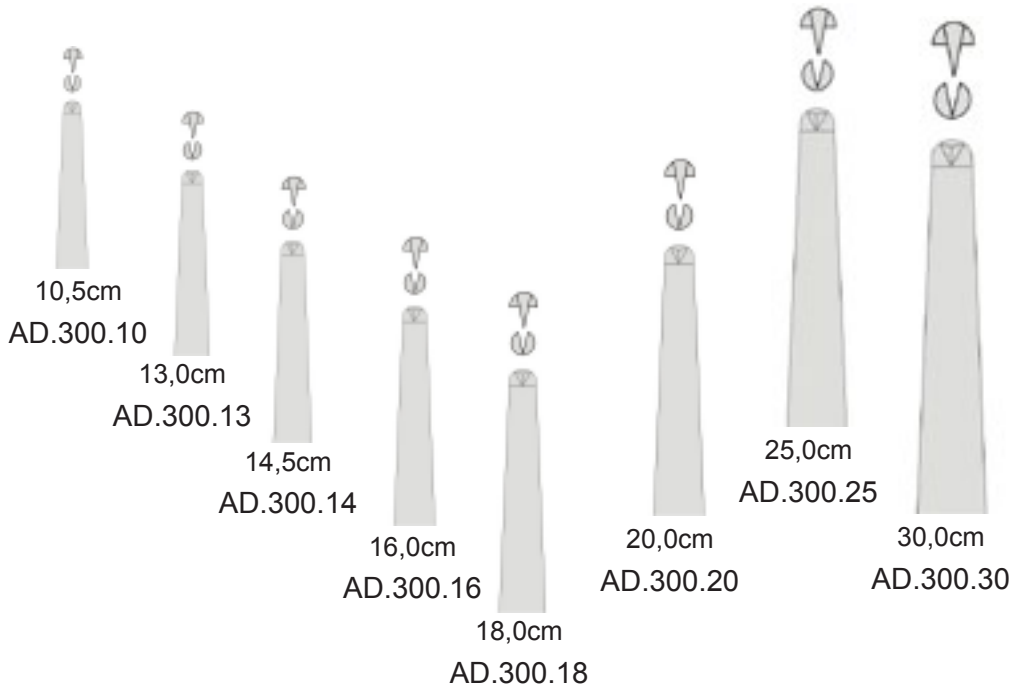

Standard

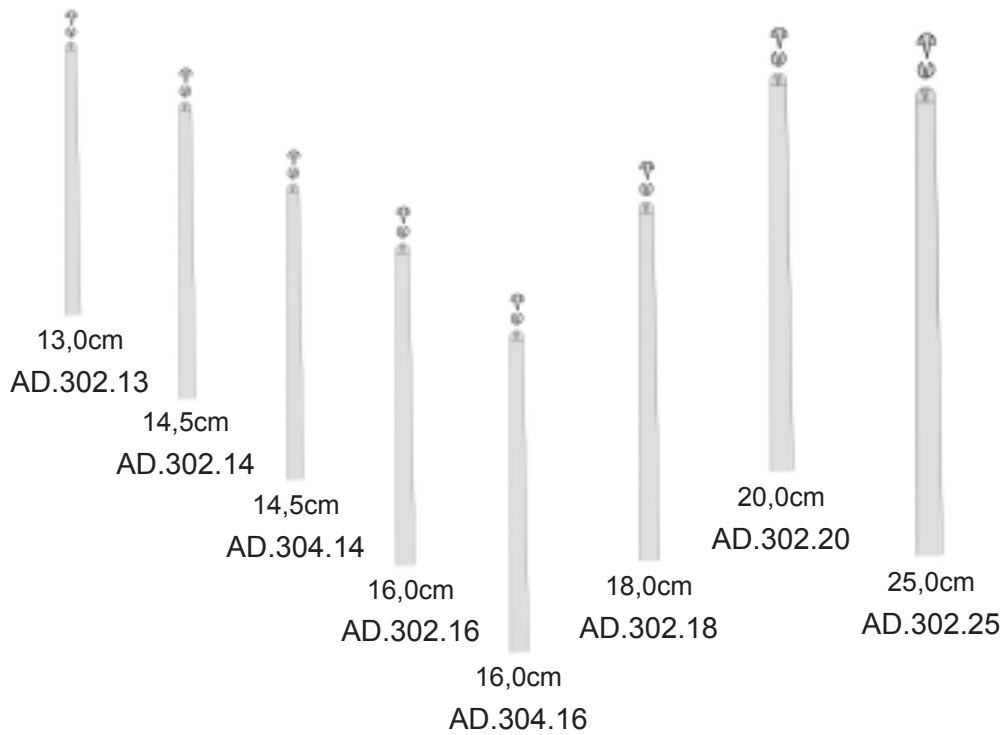

CHIRURGISCHE PINZETTEN TISSUE FORCEPS

PINZAS QUIRÚRGICAS
PINCES À DISSECTION À GRIFFES
PINZE CHIRURGICHA A DENTI DI TOPO

AD



13,0cm
AD.306.13

14,5cm
AD.306.14

16,0cm
AD.306.16

18,0cm
AD.306.18

20,0cm
AD.306.20



13,0cm
AD.308.13

14,5cm
AD.308.14

16,0cm
AD.308.16



14,5cm
AD.310.14

16,0cm
AD.310.16

PINZAS PARA COGER
 PINCES POUR SAISIR LES TISSUS
 PINZE PER AFFERRARE TESSUTI

FASSPINZETTEN
GRASPING FORCEPS

AD

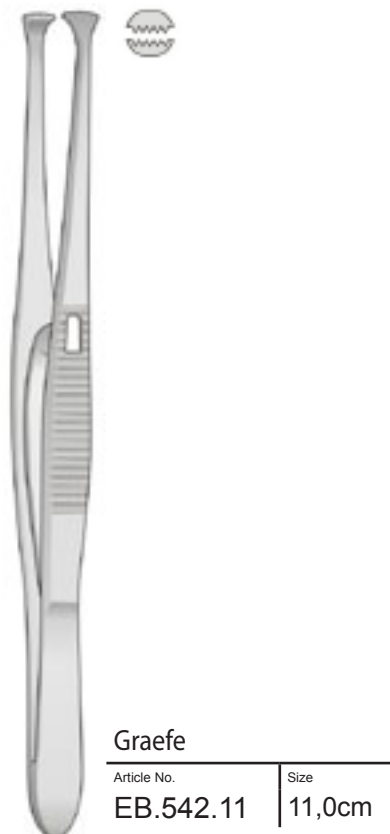
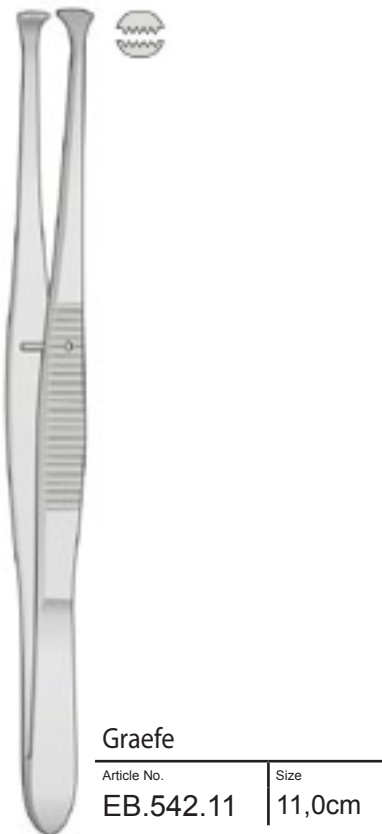
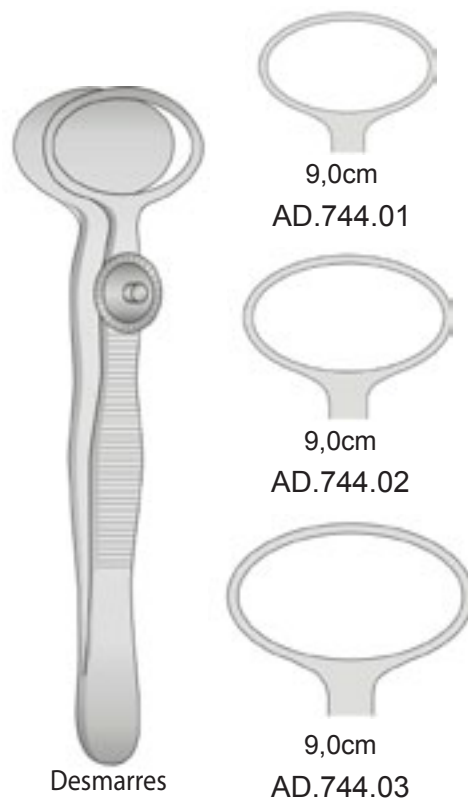
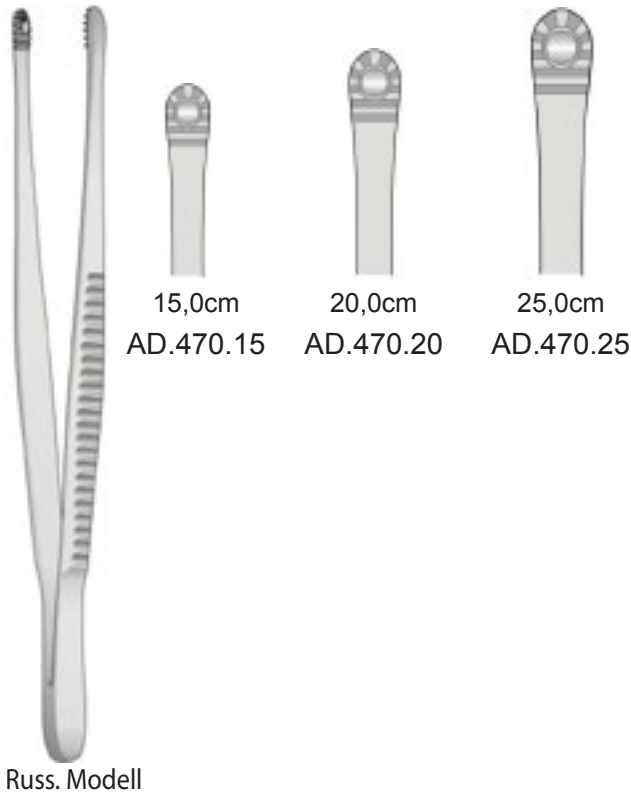

ATRAUMATISCHE PINZETTEN
ATRAUMA VASCULAR FORCEPS

ATRAUMA PINZAS VASCULARES
 PINCES ATRAUMATIQUES
 PINZE ATRAUMA

AD

1,5mm



16,0cm
AD.600.16



20,0cm
AD.600.20



24,0cm
AD.600.24

2,0mm



16,0cm
AD.602.16



20,0cm
AD.602.20



24,0cm
AD.602.24



30,0cm
AD.602.30

2,7mm



16,0cm
AD.604.16



20,0cm
AD.604.20



24,0cm
AD.604.24



30,0cm
AD.604.30

3,5mm



16,0cm
AD.606.16



20,0cm
AD.606.20



24,0cm
AD.606.24



30,0cm
AD.606.30

2,0mm



16,0cm
AD.612.16



20,0cm
AD.612.20



24,0cm
AD.612.24



30,0cm
AD.612.30



De Bakey



Griffteil gerieft, mit Stift

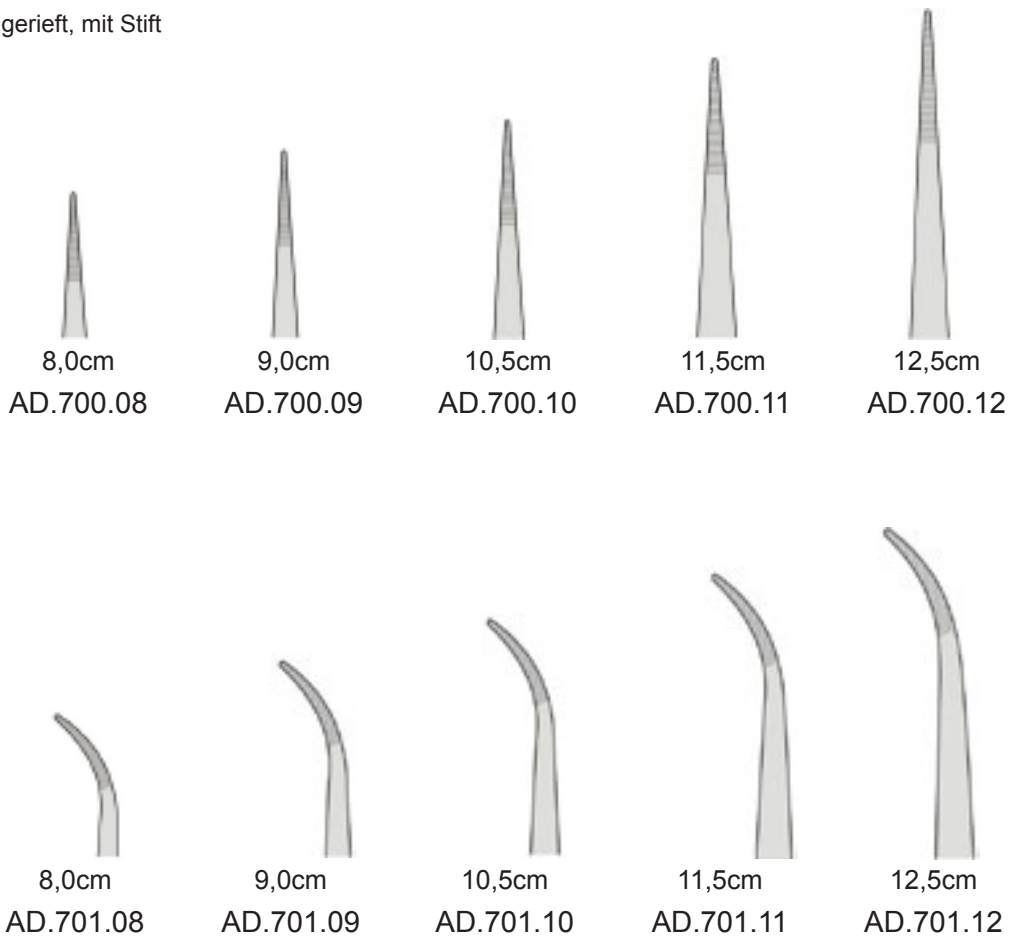

Gerade ohne Stift

Splitter Pinzette

Article No.	Size
AD.704.08	8,0cm

CILIENPINZETTEN
CILIA FORCEPS

PINZAS DEPILATORIAS
PINCES À ÉPILER LES CILS
PINZE DELPILATORIE

AD



Douglas

Article No.	Size
AD.730.09	9,0cm



Article No.	Size
AD.727.09	9,0cm



Article No.	Size
AD.728.09	9,0cm



Article No.	Size
AD.734.09	9,0cm

AD

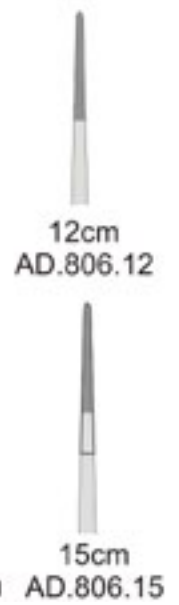
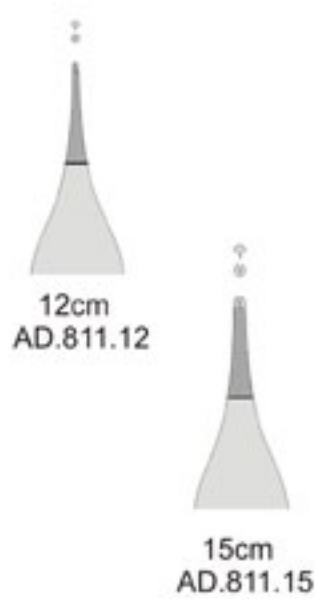
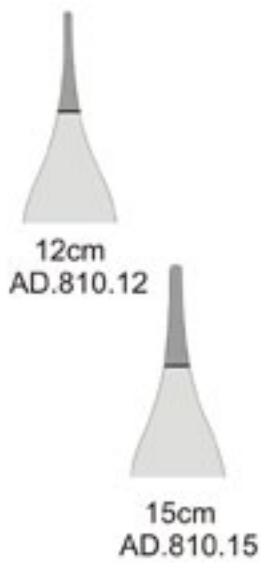
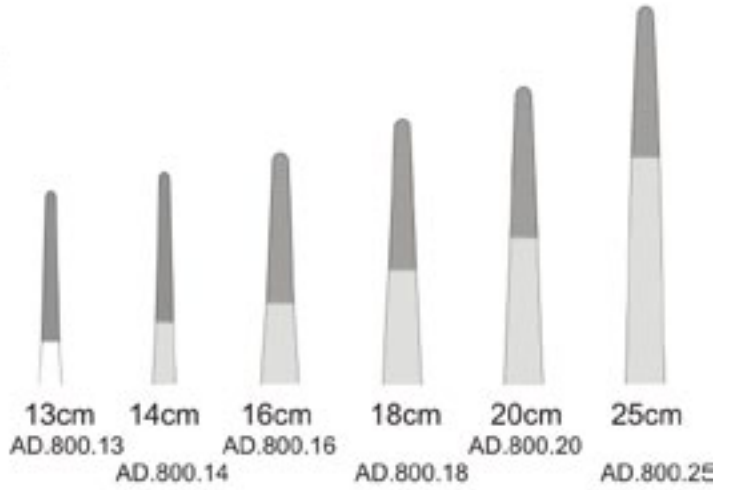
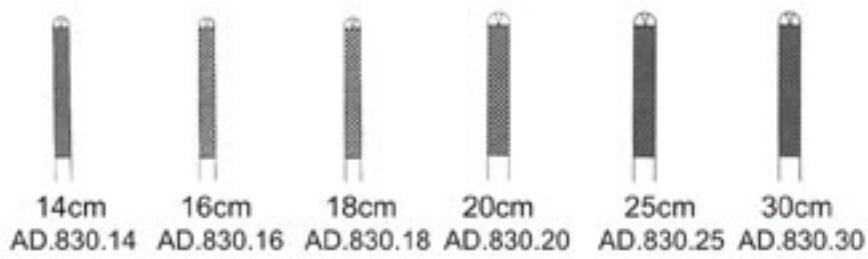

HM PINZETTEN DISSECTING FORCEPS WITH TC

PINZAS DE DISECCIÓN CON INSERCIONES DE TUNGSTENO
PINCES PLAQUETTES EN CARBURE DE TUNGSTÈNE
PINZE PER DISSEZIONE CON TAGLIO IN CARBURO DI TUGSTENO

AD

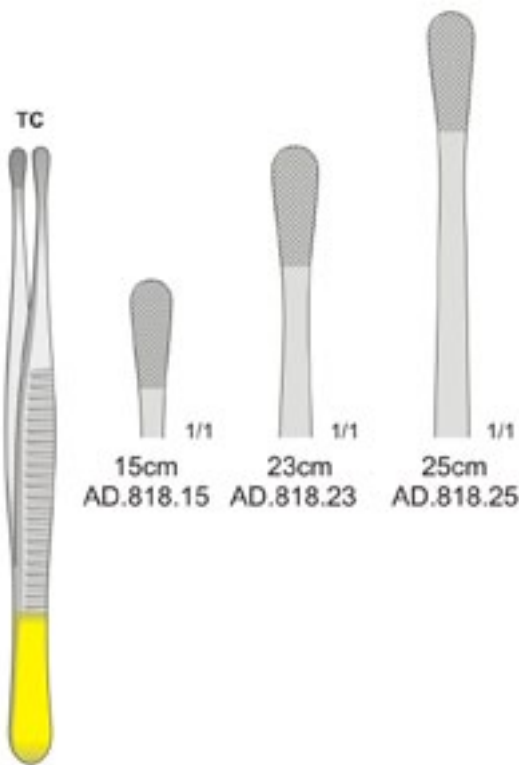

Wangenstein

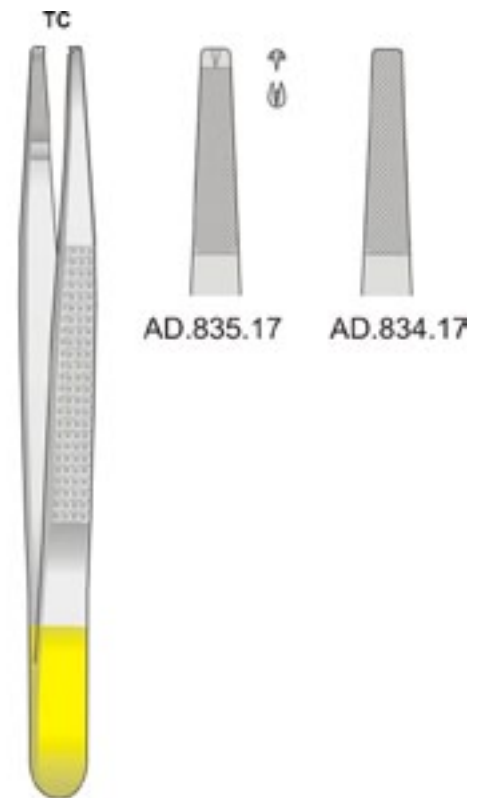

Bonney 17cm

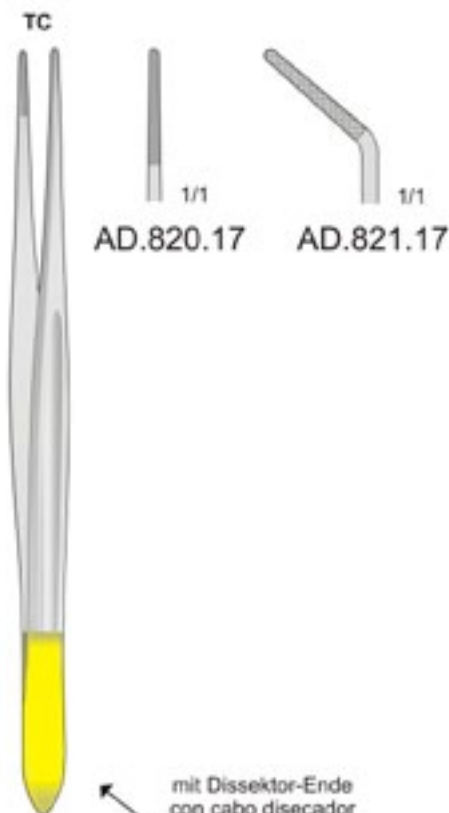

Cushing 17cm

mit Dissektor-Ende
con cabo disecador
avec bout disecteur
con dissettore

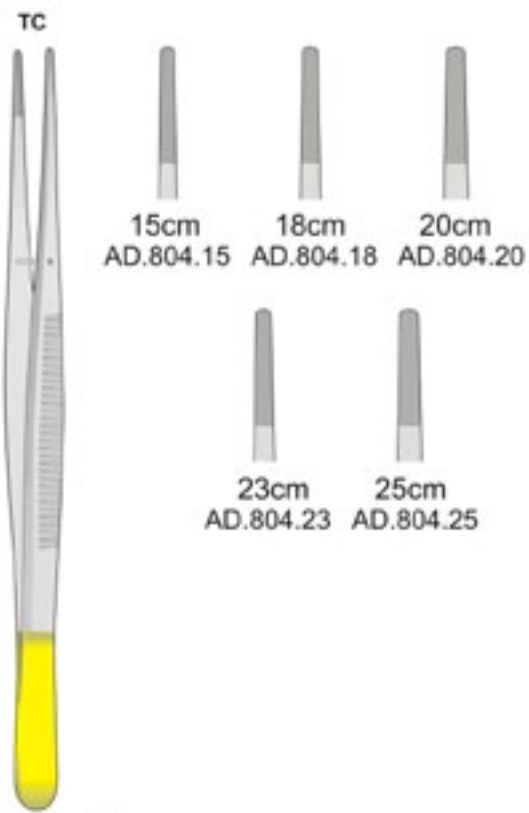





Potts Smith

PINZAS DE DISECCIÓN CON INSERCIONES DE TUNGSTENO
 PINCES PLAQUETTES EN CARBURE DE TUNGSTÈNE
 PINZE PER DISSEZIONE CON TAGLIO IN CARBURO DI TUGSTENO

HM PINZETTEN DISSECTING FORCEPS WITH TC

AD

	 1,5mm	 2,0mm	 2,7mm	 3,5mm
	16cm AD.850.16	16cm AD.851.16	16cm AD.852.16	16cm AD.853.16
	20cm AD.850.20	20cm AD.851.20	20cm AD.852.20	20cm AD.853.20
	25cm AD.850.25	25cm AD.851.25	25cm AD.852.25	

DeBAKEY



Evans 25cm
 AD.855.25

NADELHALTER
NEEDLE HOLDERS

PORTA-AGUJAS
PORTE-AIGUILLES
PORTAGHI

AF

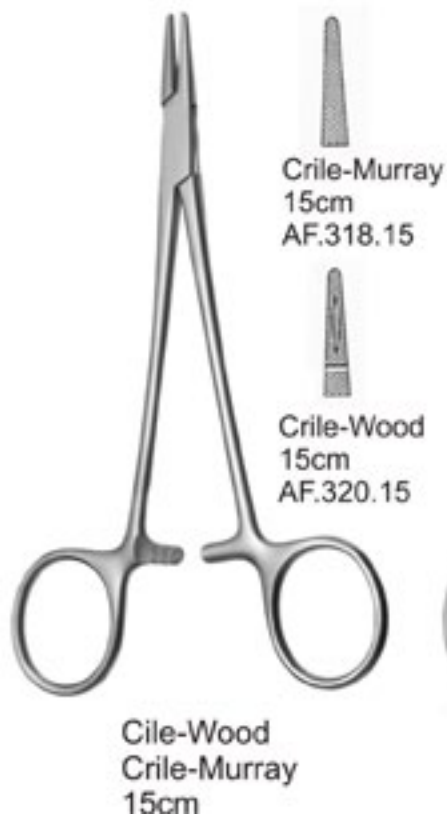



Mayo-Hegar



14cm
AF.330.14



16cm
AF.330.16

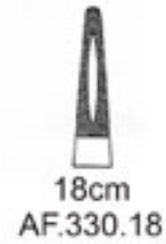

18cm
AF.330.18



20cm
AF.330.20



24cm
AF.330.24

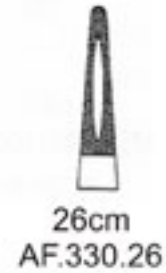

26cm
AF.330.26



Heaney 21cm
AF.336.21



Masson 27cm
AF.340.27

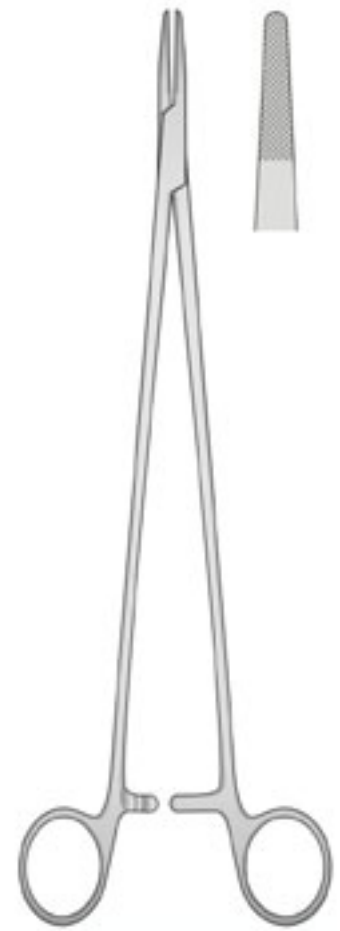

Wangensteen 27cm
AF.344.27

NADELHALTER
NEEDLE HOLDERS

PORTA-AGUJAS
PORTE-AIGUILLES
PORTAGHI

AF



Mathieu



14cm
AF.380.14



17cm
AF.380.17



20cm
AF.380.20



Castroviejo 14cm



AF.430.14



AF.431.14



Castroviejo 16cm



AF.430.18



AF.431.18



Castroviejo 22,5cm



AF.430.22



AF.431.22

NADELHALTER MIT HM
NEEDLE HOLDERS WITH TC

AF

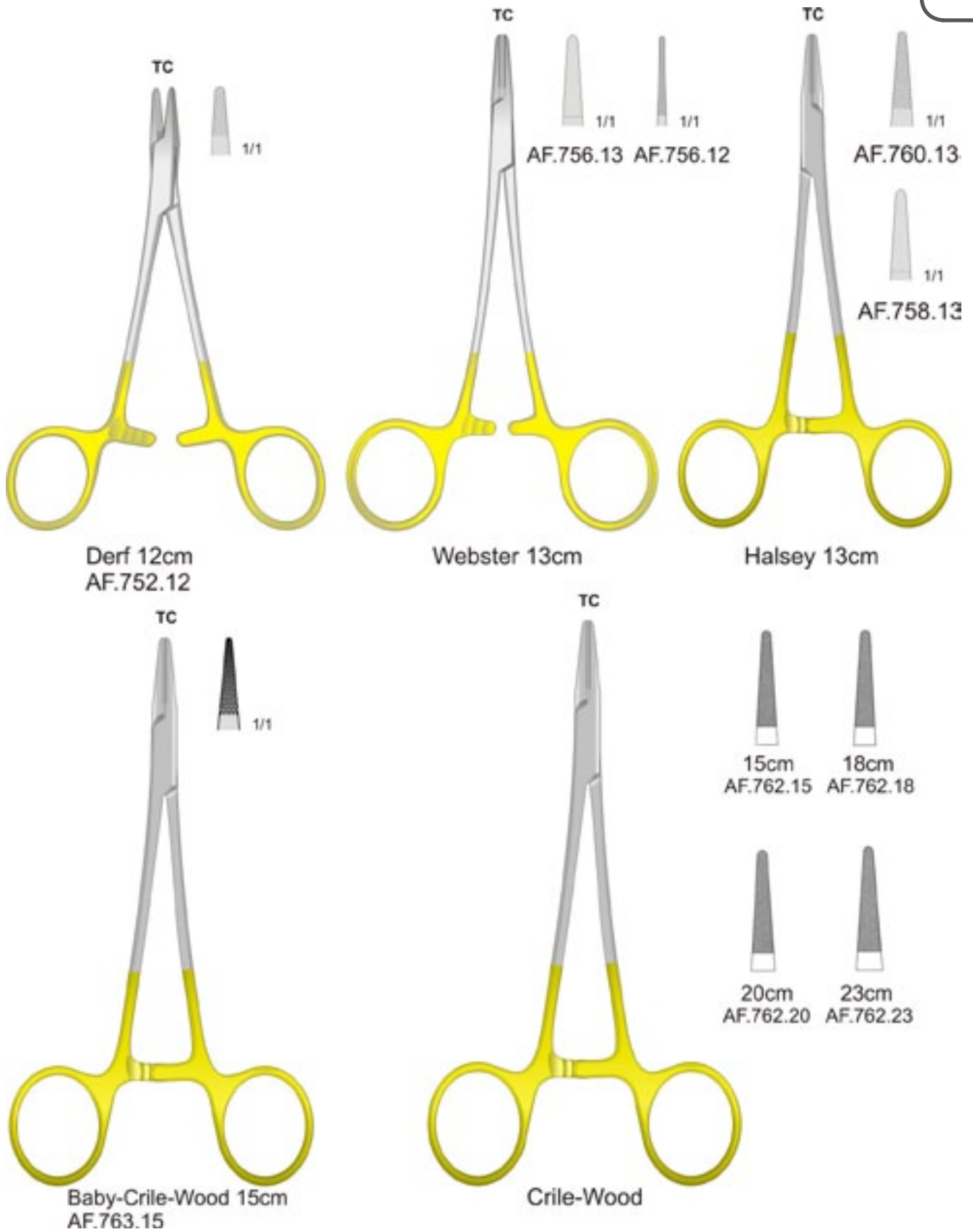

NADELHALTER MIT HM
NEEDLE HOLDERS WITH TC

PORTA-AGUJAS CON INSERCIONES DE TUNGSTENO
 PORTE-AIGUILLES AVEC PLAQUETTES EN CARBURE DE TUNGSTÈNE
 PORTAGHI CON INSERTI AL TUNGSTENO

AF



Schewd. Modell 15cm
 AF.766.15

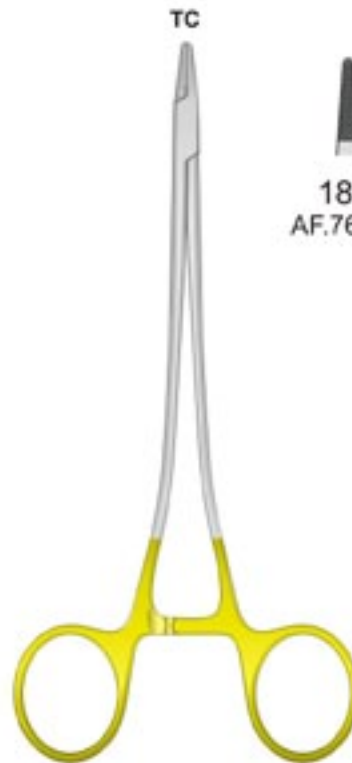

Sarot

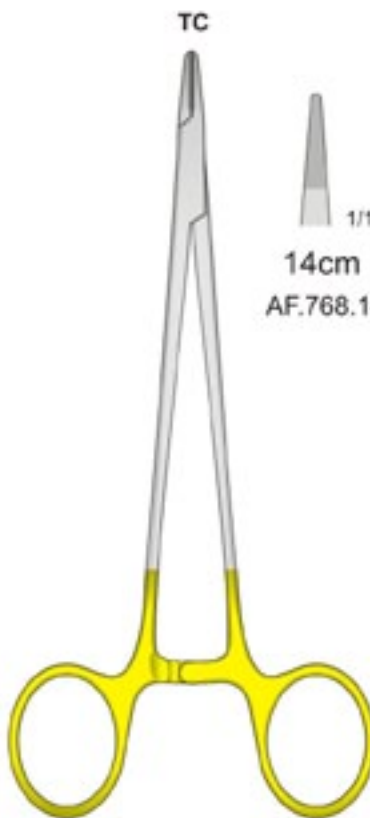

Mayo-Hegar

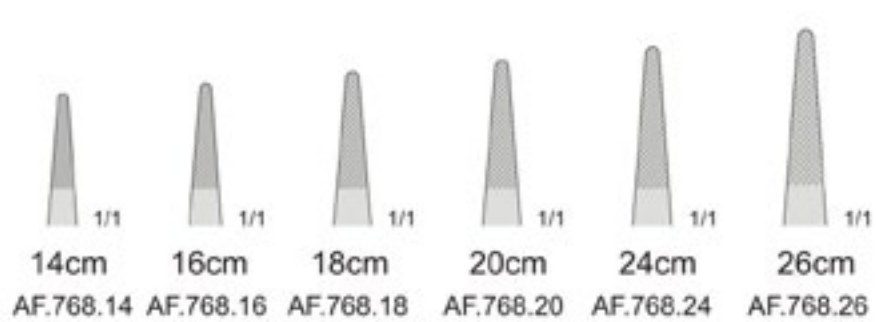

NADELHALTER MIT HM
NEEDLE HOLDERS WITH TC

AF

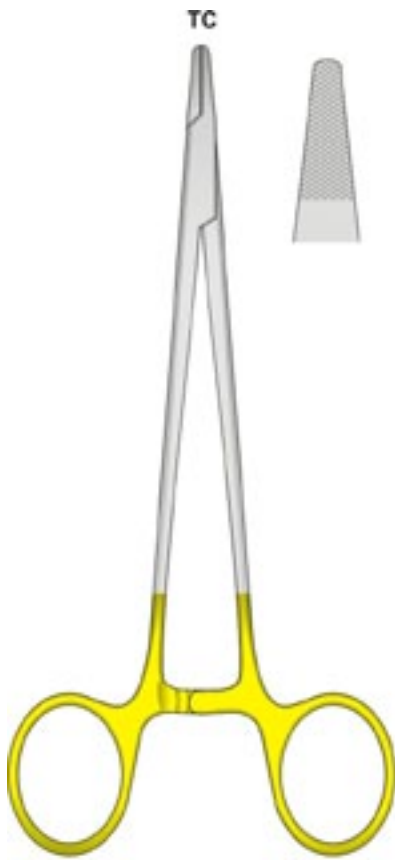

Mayo-Hegar 20cm
 schwere Ausführung
 AF.770.20



MEDE-Vascular

- | | | | |
|-------------------|-------------------|-------------------|-------------------|
| | | | |
| 15cm
AF.771.15 | 18cm
AF.771.18 | 20cm
AF.771.20 | 23cm
AF.771.23 |

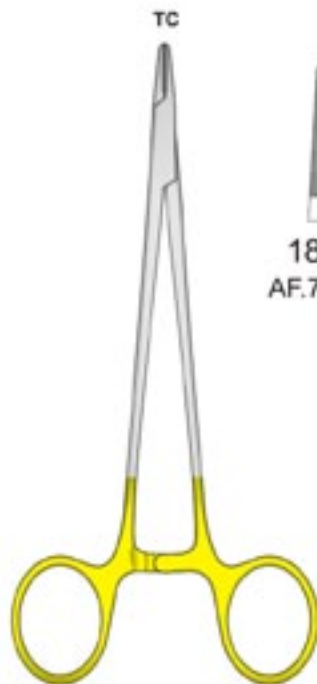

De Bakey

- | | | | | |
|-------------------|-------------------|-------------------|-------------------|-------------------|
| | | | | |
| 18cm
AF.772.18 | 20cm
AF.772.20 | 23cm
AF.772.23 | 26cm
AF.772.26 | 31cm
AF.772.31 |

NADELHALTER MIT HM
NEEDLE HOLDERS WITH TC

PORTA-AGUJAS CON INSERCIONES DE TUNGSTENO
 PORTE-AIGUILLES AVEC PLAQUETTES EN CARBURE DE TUNGSTÈNE
 PORTAGHI CON INSERTI AL TUNGSTENO

AF

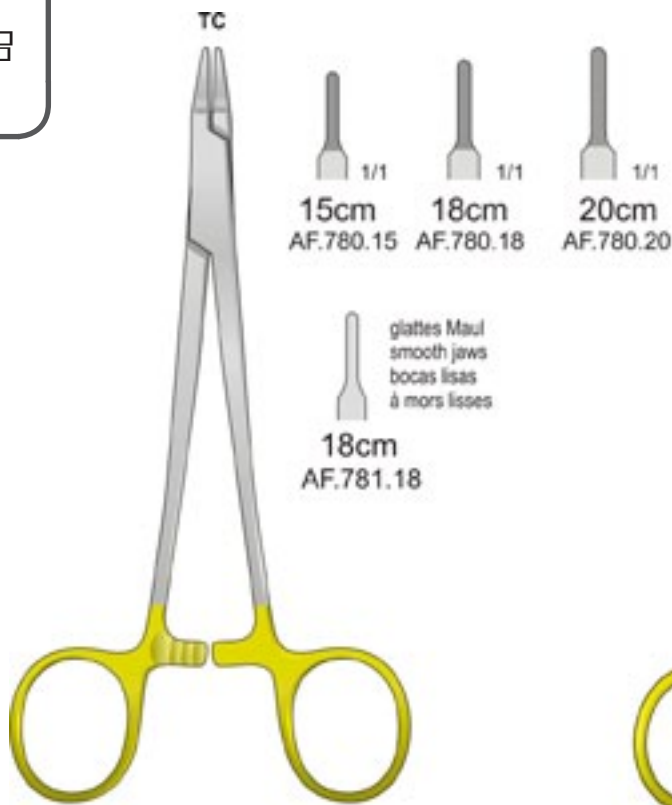

Ryder (Frenche eye)

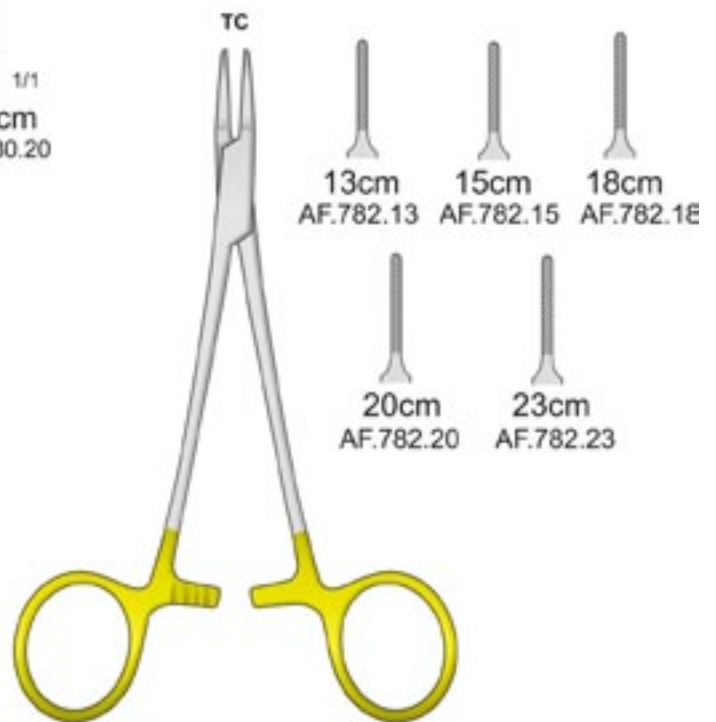

Micro-Ryder

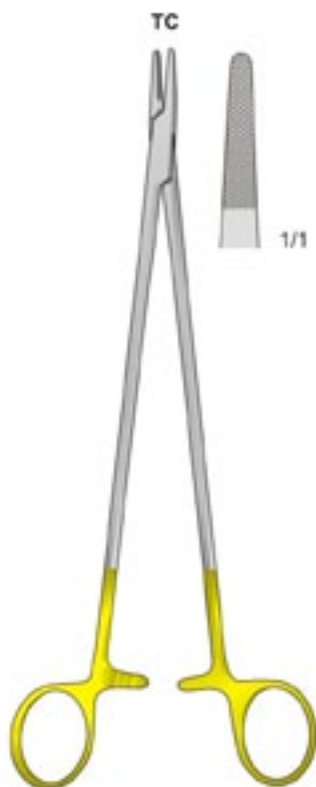

Masson 27cm
 AF.776.27



Wangenstein 27cm
 AF.790.27

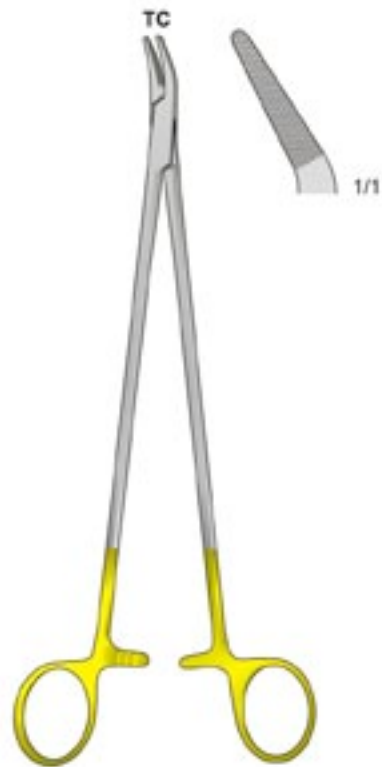

Finochietto 27cm
 AF.791.27

PORTA-AGUJAS CON INSERCIONES DE TUNGSTENO
 PORTE-AIGUILLES AVEC PLAQUETTES EN CARBURE DE TUNGSTÈNE
 PORTAGHI CON INSERTI AL TUNGSTENO

NADELHALTER MIT HM
NEEDLE HOLDERS WITH TC

AF

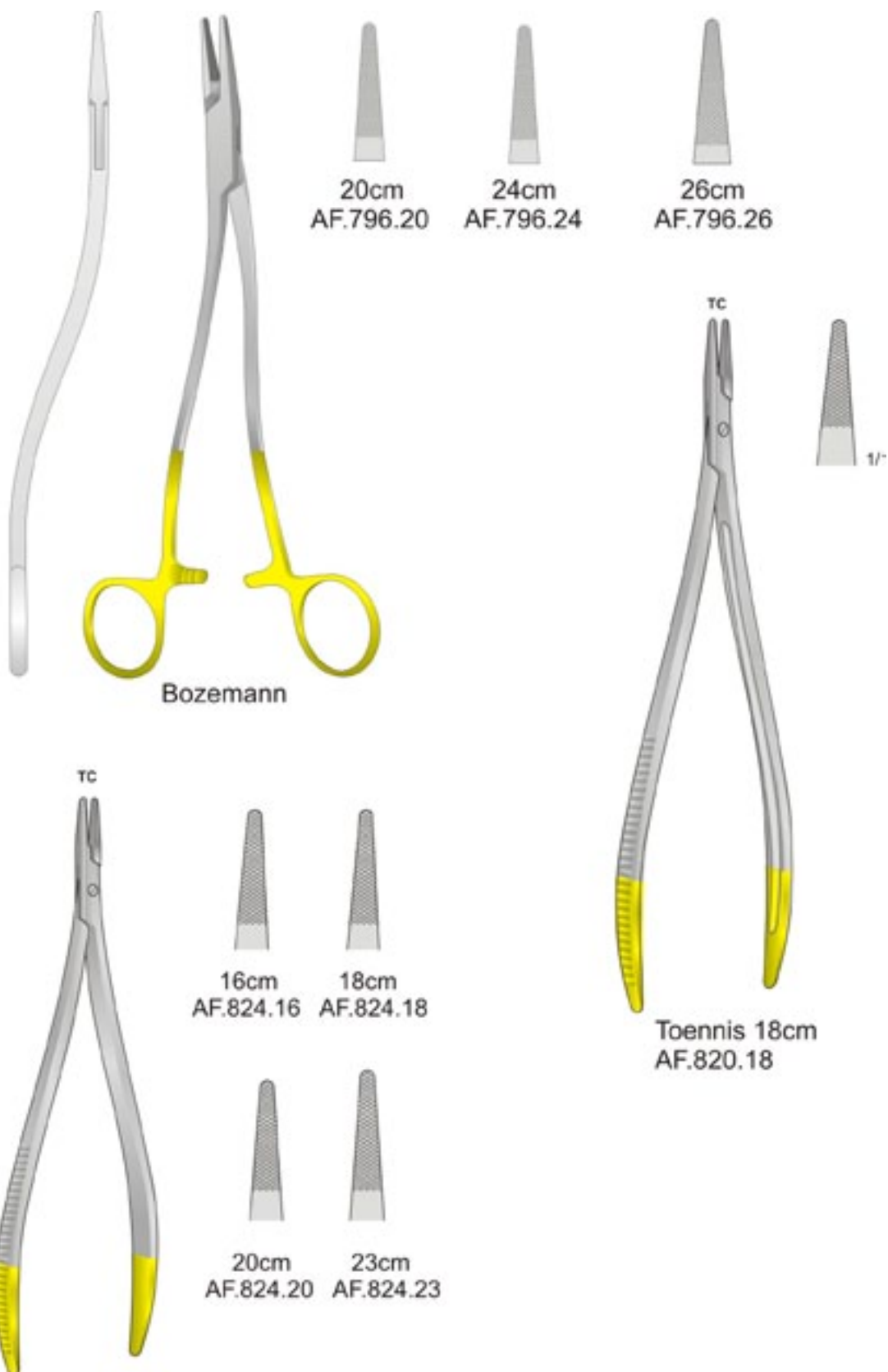

NADELHALTER MIT HM
NEEDLE HOLDERS WITH TC

PORTA-AGUJAS CON INSERCIONES DE TUNGSTENO
 PORTE-AIGUILLES AVEC PLAQUETTES EN CARBURE DE TUNGSTÈNE
 PORTAGHI CON INSERTI AL TUNGSTENO

AF

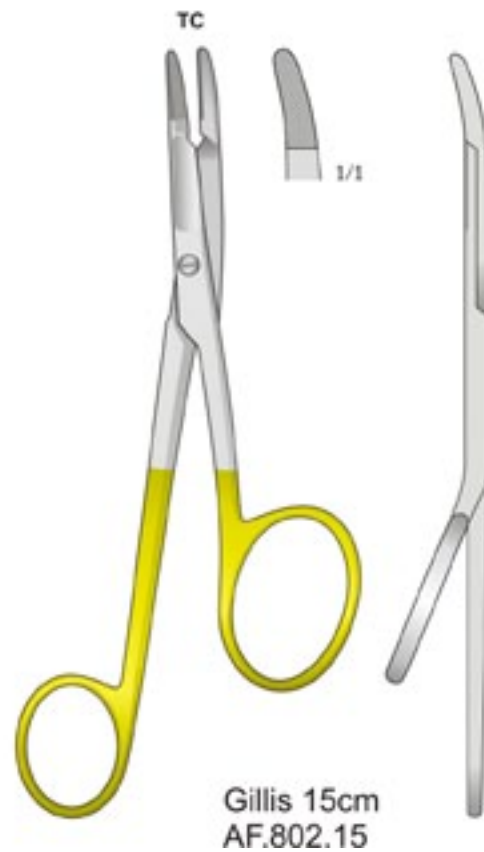
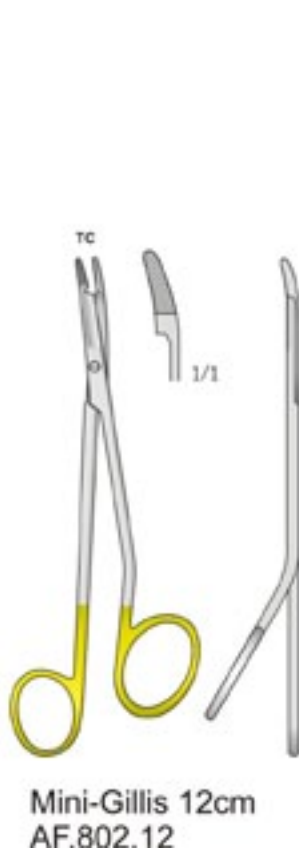
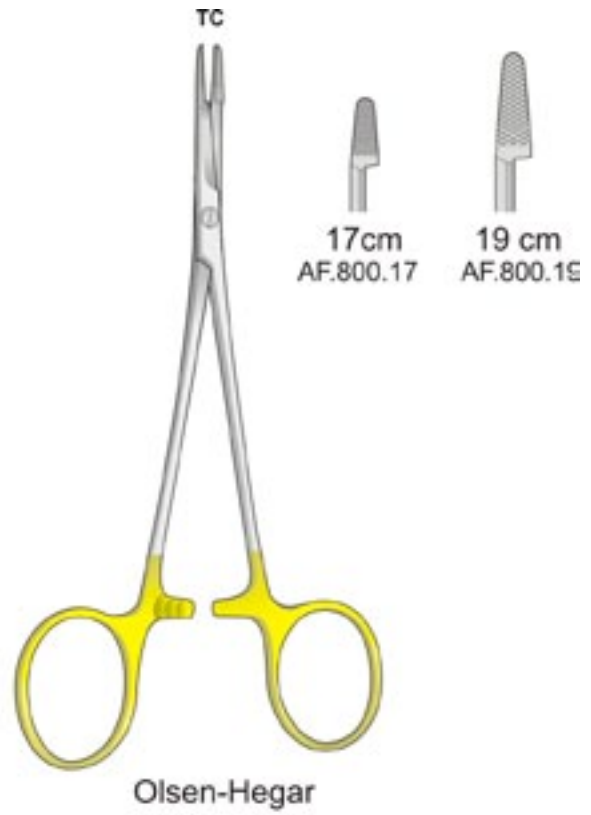

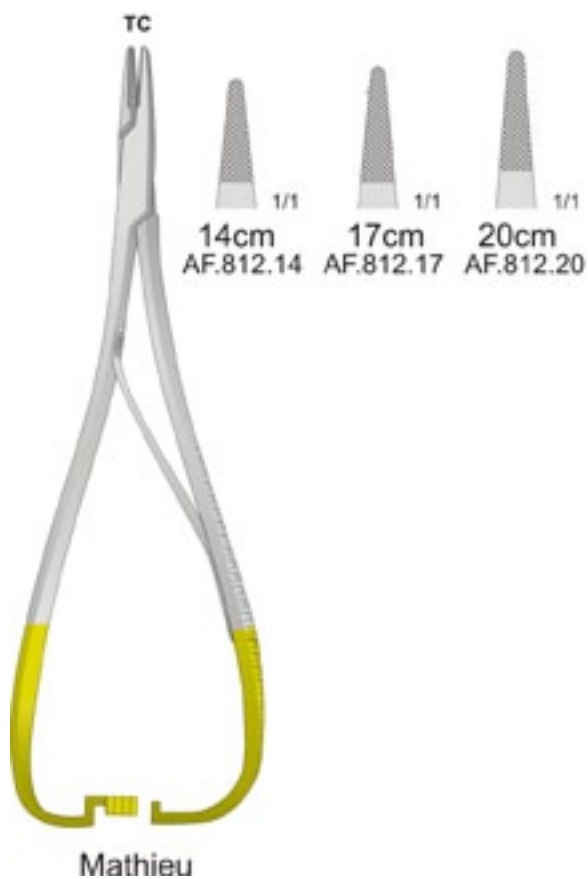

AF



Hegenbarth

Article No.	Size
AF.886.12	12,5cm



Collin

Article No.	Size
AF.892.13	13,0cm



Michel

Article No.	Size
AF.890.12	12,0cm



Michel

Article No.	Size
AF.891.13	13,0cm



Klammerentferner

Article No.	Size
AF.896.12	12,0cm

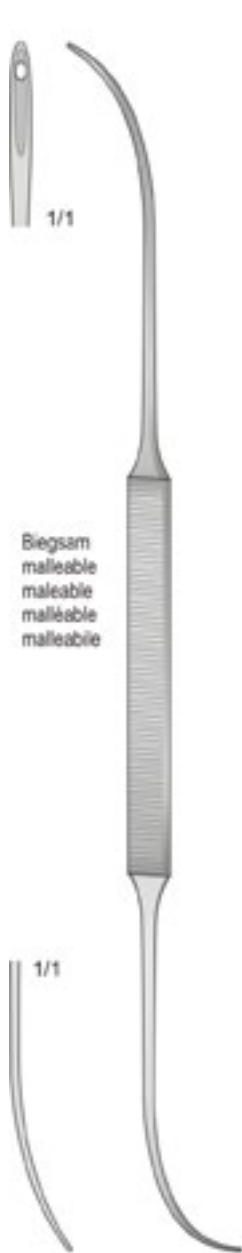

Biegsam
malleable
maleable
malleable

Schmieden-Dick
32cm
AF.920.32

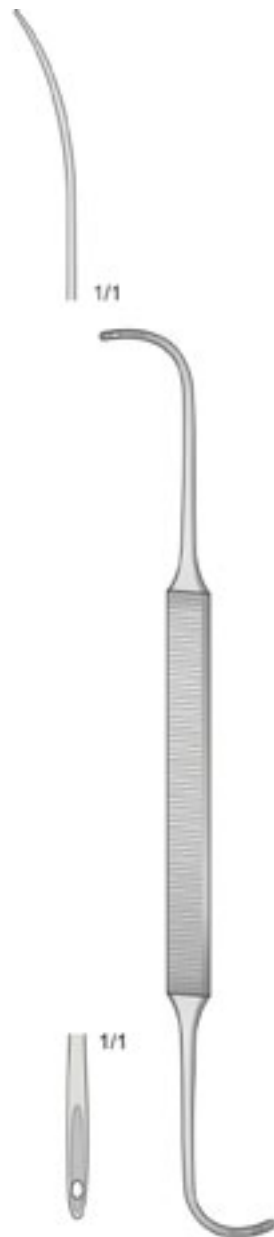

Schmieden 21cm
AF.922.21

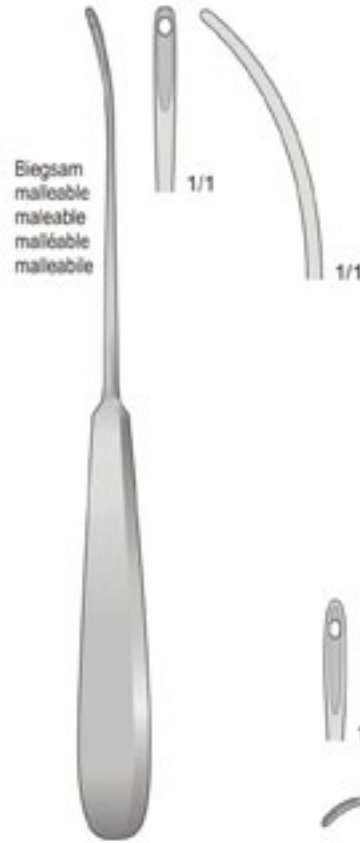

Biegsam
malleable
maleable
malleable

20cm
AF.924.20



Copper 19cm
AF.926.19

UNTERBINDUNGSNADELN
LIGATURE NEEDLES

AGUJAS PARA LIGADURAS
 AIGUILLES À LIGATURES
 AGHI PER LEGATURA

AF



Kronecker 13cm
 AF.940.13 AF.942.13



Deschamps 20cm
 AF.955.20 AF.956.20



Deschamps 20cm
 AF.957.20 AF.958.20

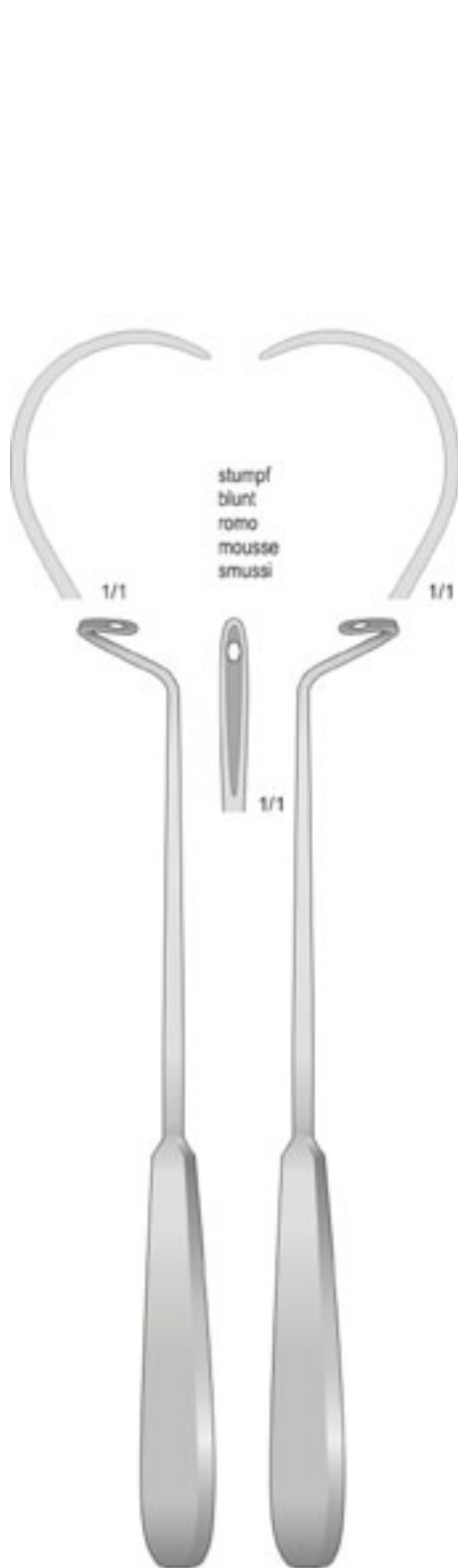

Deschamps 24cm
AF.950.24 AF.952.24

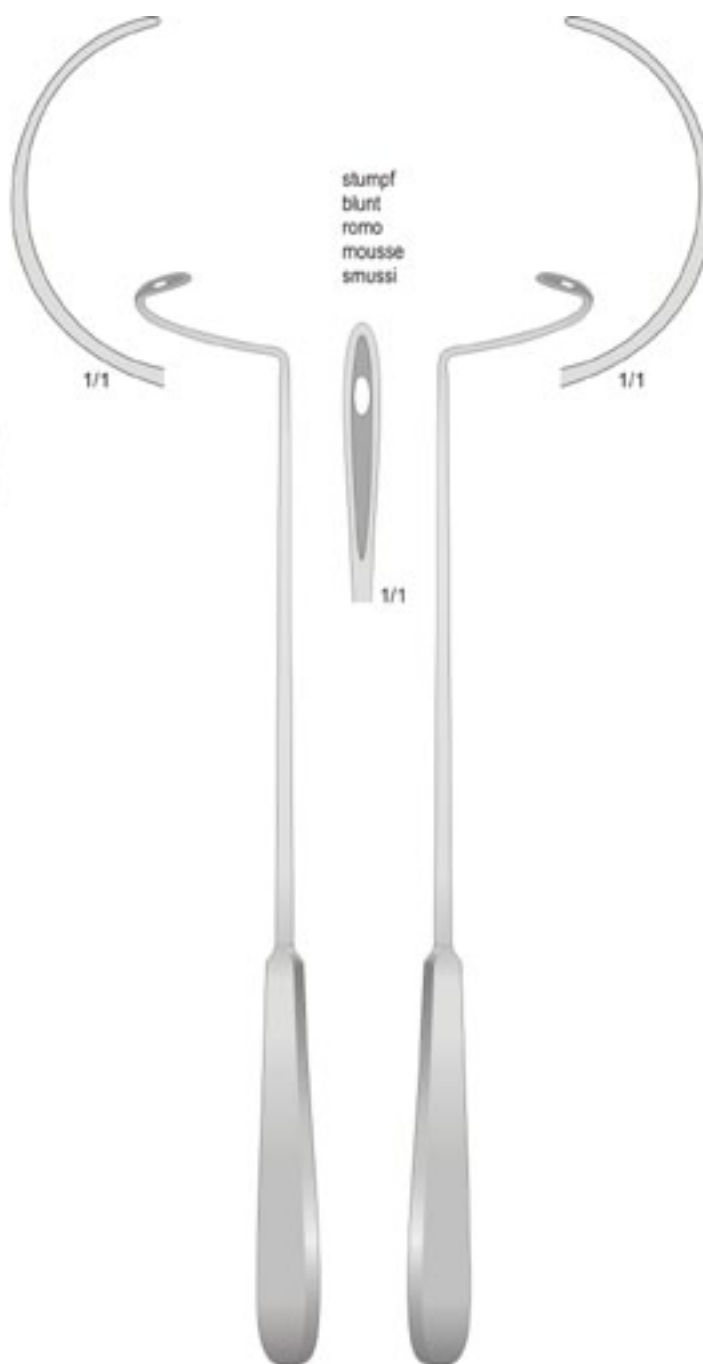

Deschamps 28cm
AF.967.28 AF.968.28

UNTERBINDUNGSNADELN
LIGATURE NEEDLES

AGUJAS PARA LIGADURAS
 AIGUILLES À LIGATURES
 AGHI PER LEGATURA

AF



Deschamps 27cm
 AF.963.01 AF.963.02



Deschamps 27cm
 AF.964.01 AF.964.02

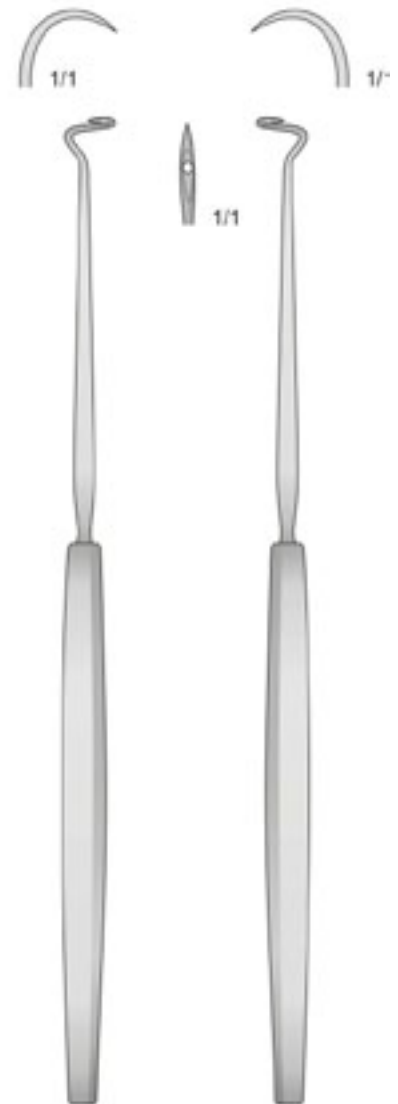

Dupuy-Weiss 22cm
 GF.130.01 GF.130.02

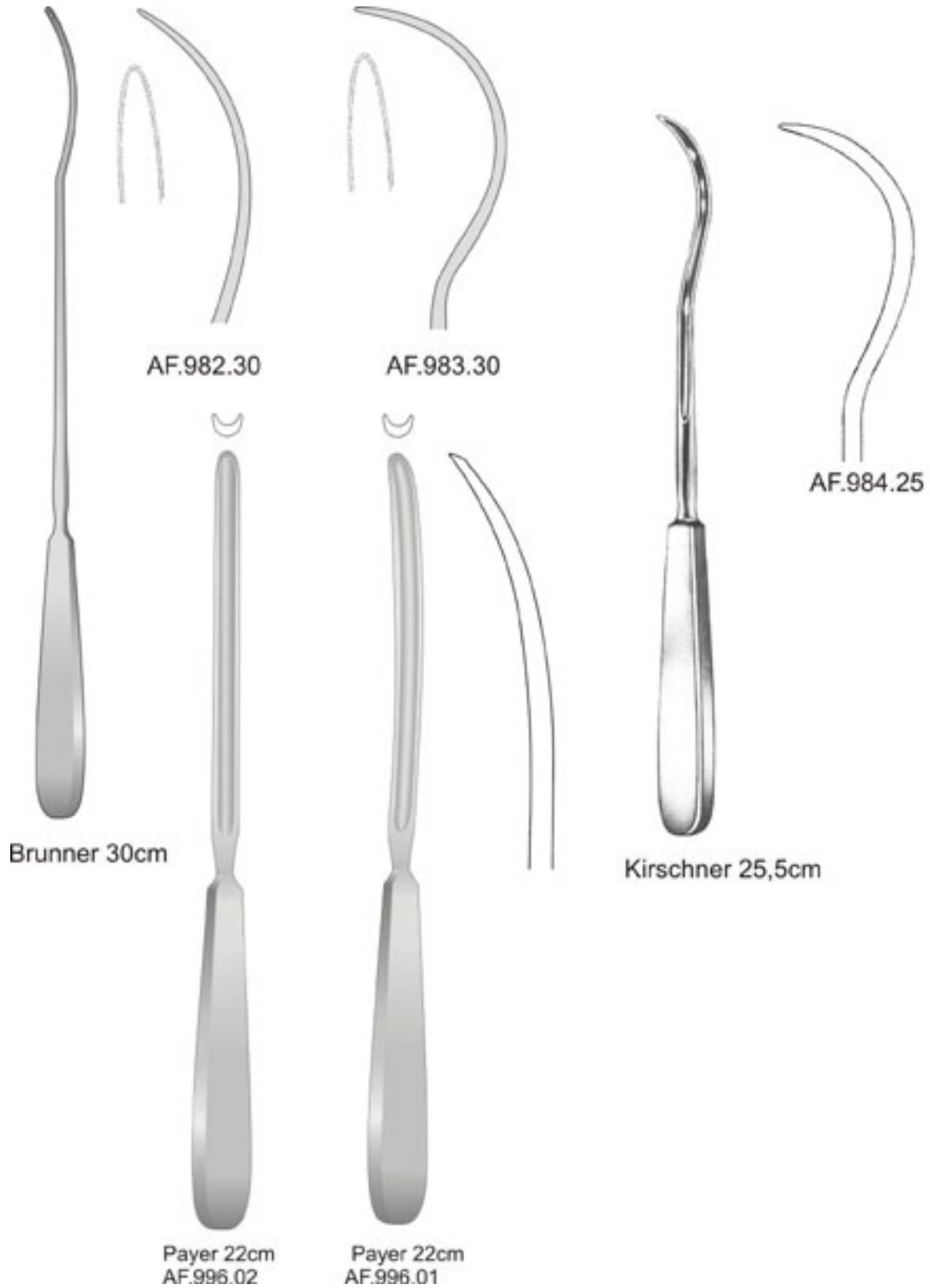

FÜHRUNGSHOHLSONDEN
LIGATURE CONDUCTORS

SONDAS CONDUCTORAS
 SONDES CONDUCTRICES
 SONDE CONDUTTRICI

AF



König 19,5cm

2,5mm
 AF.995.03

5mm
 AF.995.05

7mm
 AF.995.07



Kocher 16cm



AF.986.01



AF.986.02



Schmieden 19cm
 AF.993.19



Schmieden-Payr 19cm
 AF.994.19





Brunner-Ferrozell
18,5cm
AF.987.18



Kirschner-Ferrozell
27cm
AF.987.27



Ferrozell 19cm
gerade
straight
rectas
droite
retta
AF.990.02

gebogen
curved
curvas
courbe
curva

AF.990.01



Ferrozell 24cm
AF.992.24

ARTERIENKLEMMEN
HEMOSTATIC FORCEPS

PINZAS HEMOSTÁTICAS
PINCES HÉMOSTATIQUES
PINZE EMOSTATICHE

AH

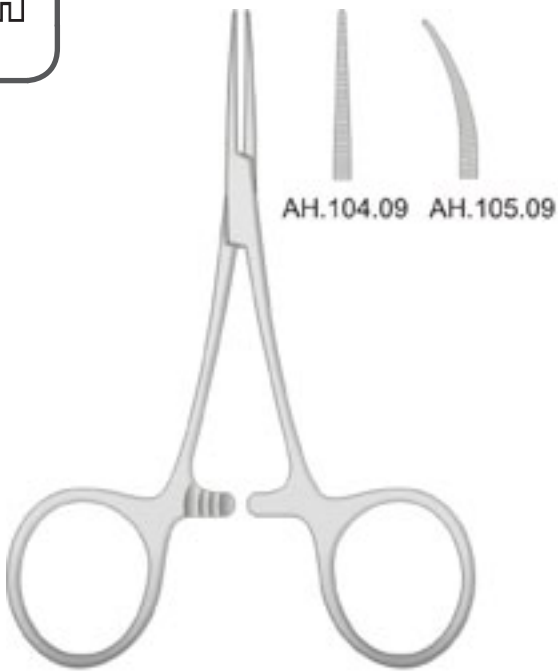

Hartmann
9cm



Halstead-Mosquito
12cm und 14cm



Halstead-Mosquito 1x2 Zähne
12cm und 14cm

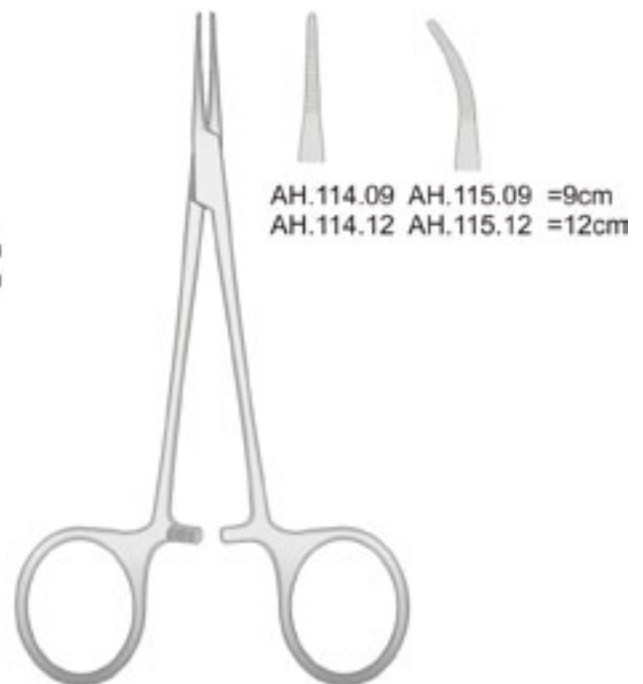

Micro-Halstead Mosquito
9cm und 12cm

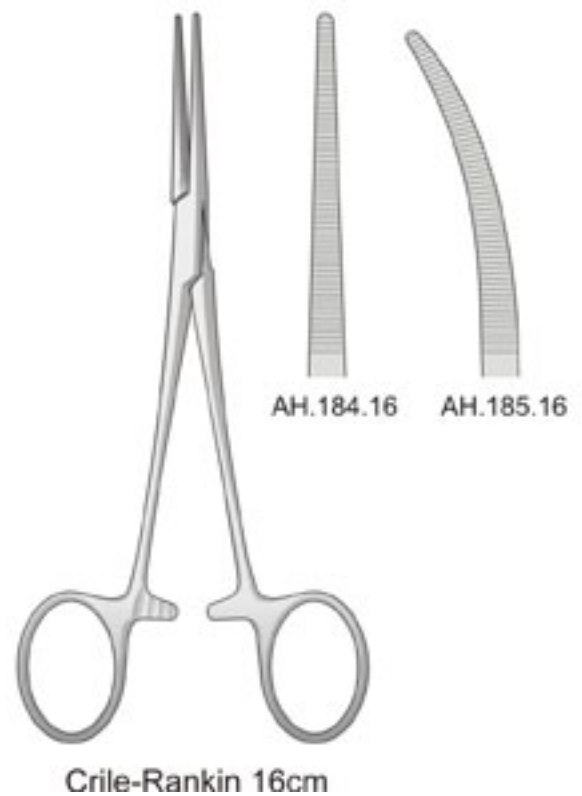
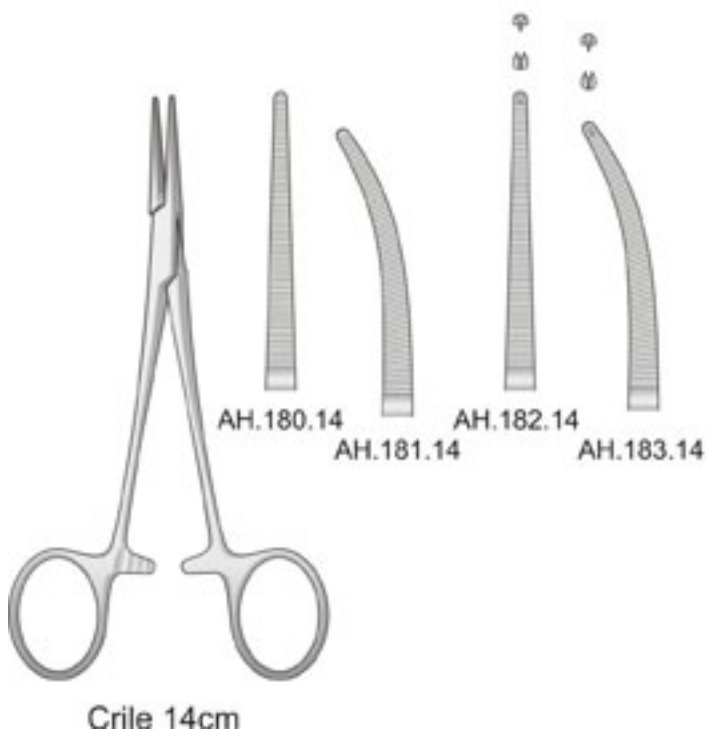
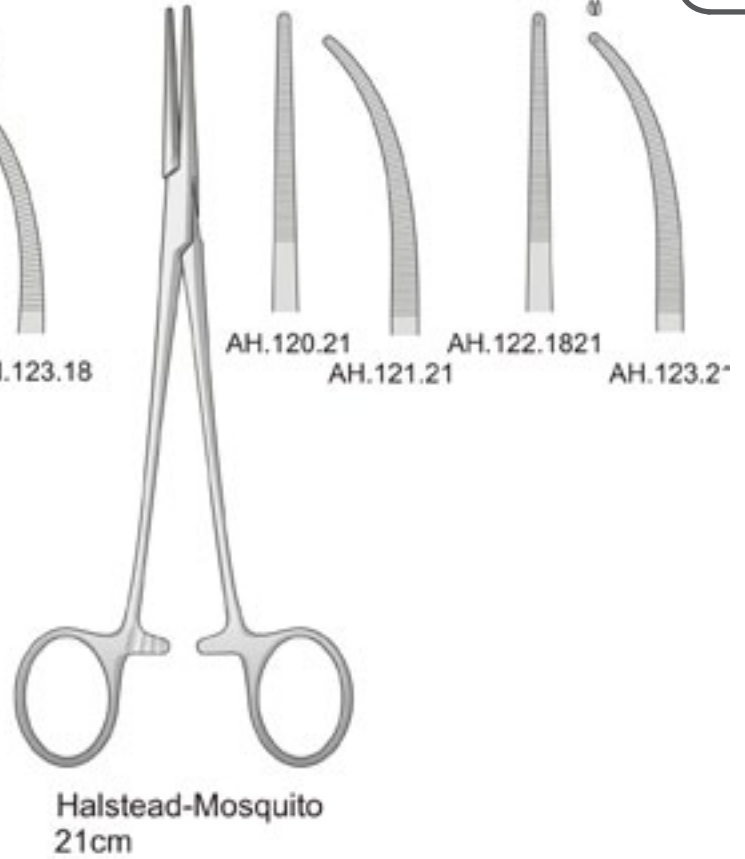
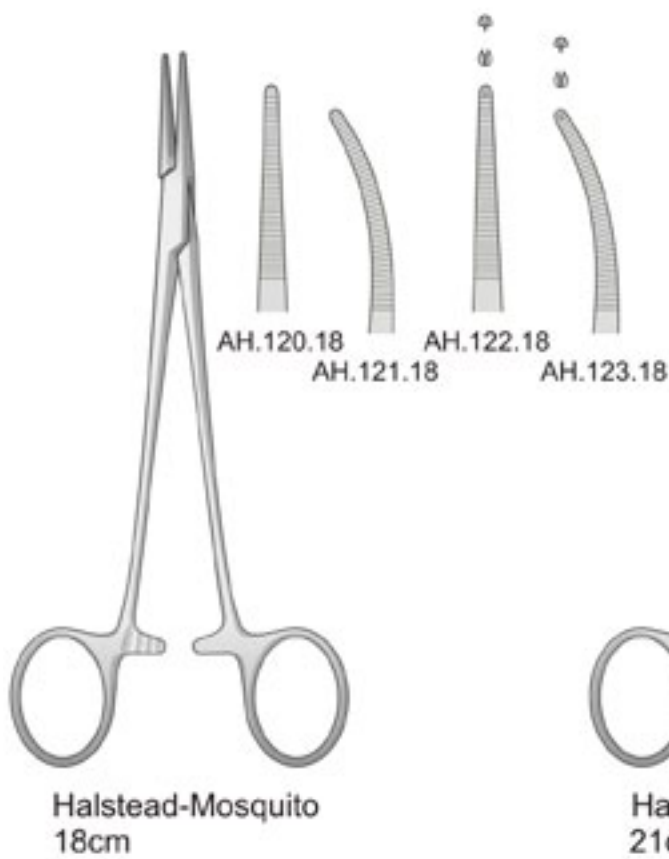

ARTERIENKLEMMEN
HEMOSTATIC FORCEPS

PINZAS HEMOSTÁTICAS
PINCES HÉMOSTATIQUES
PINZE EMOSTATICHE

AH

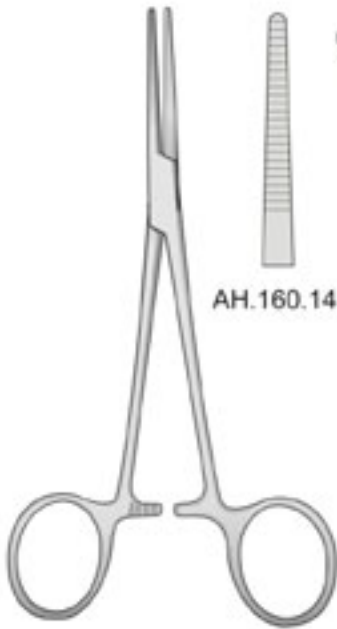

Kelly 14cm

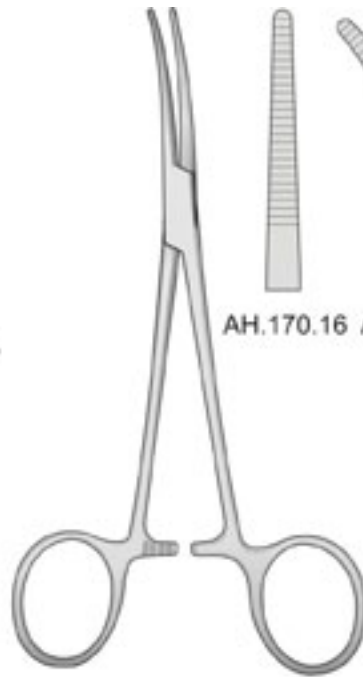

Kelly-Rankin 16cm



Mixer-Baby 14cm
AH.341.14



Dandy 14cm

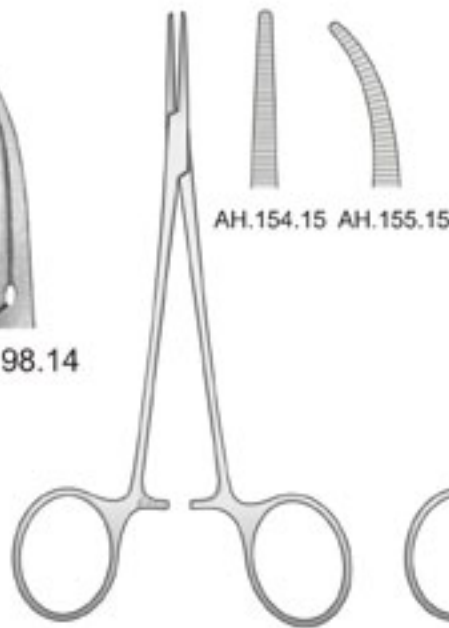

Leriche 15cm

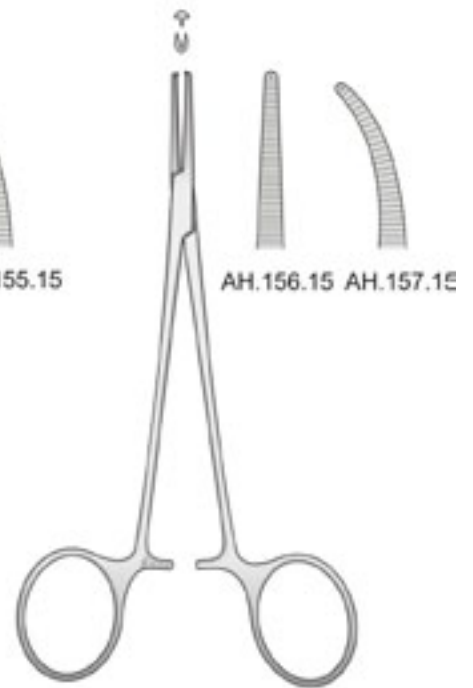

Leriche 15cm



Bengolea

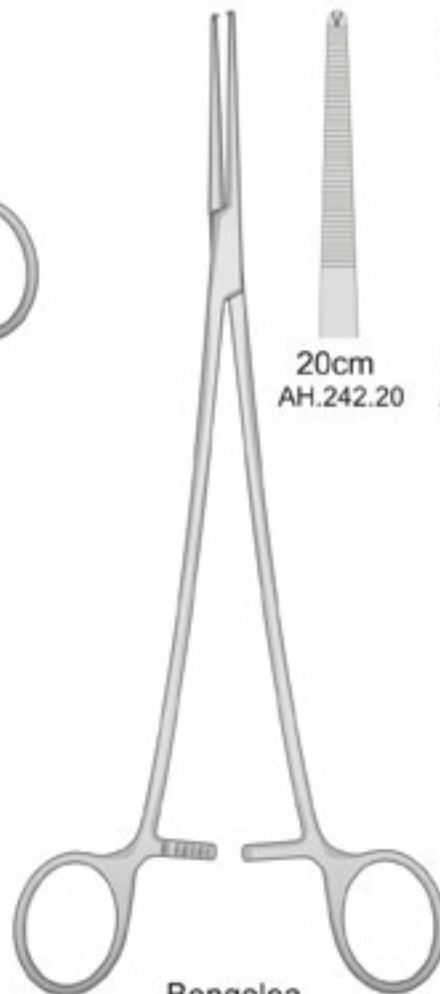
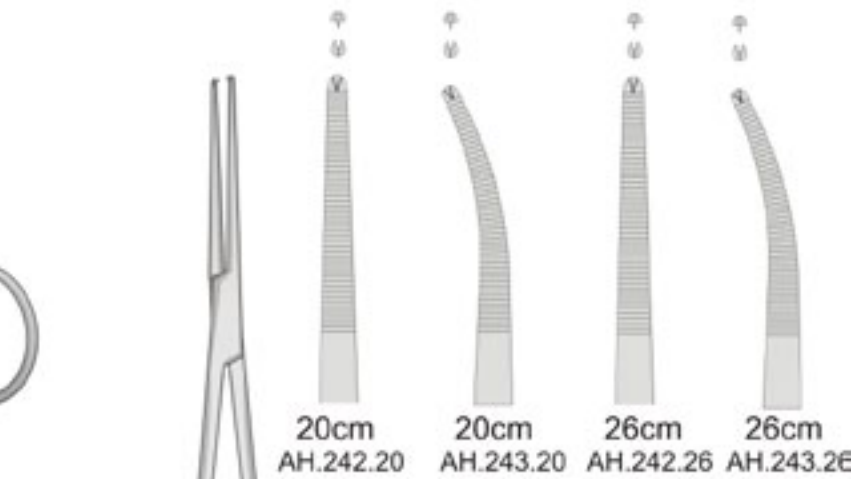
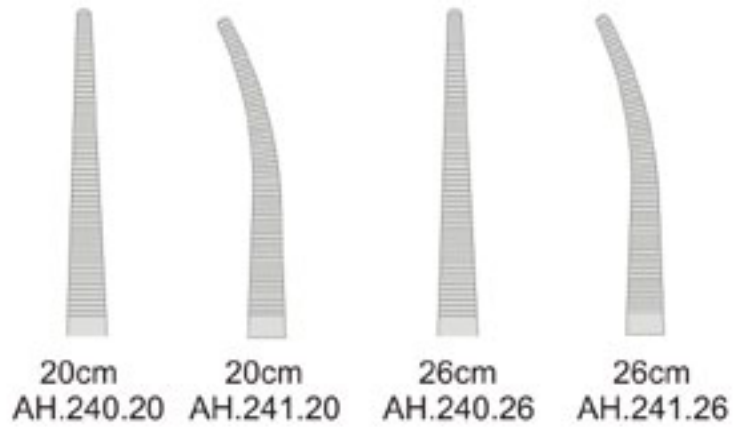

Bengolea

ARTERIENKLEMMEN
HEMOSTATIC FORCEPS

PINZAS HEMOSTÁTICAS
PINCES HÉMOSTATIQUES
PINZE EMOSTATICHE

AH

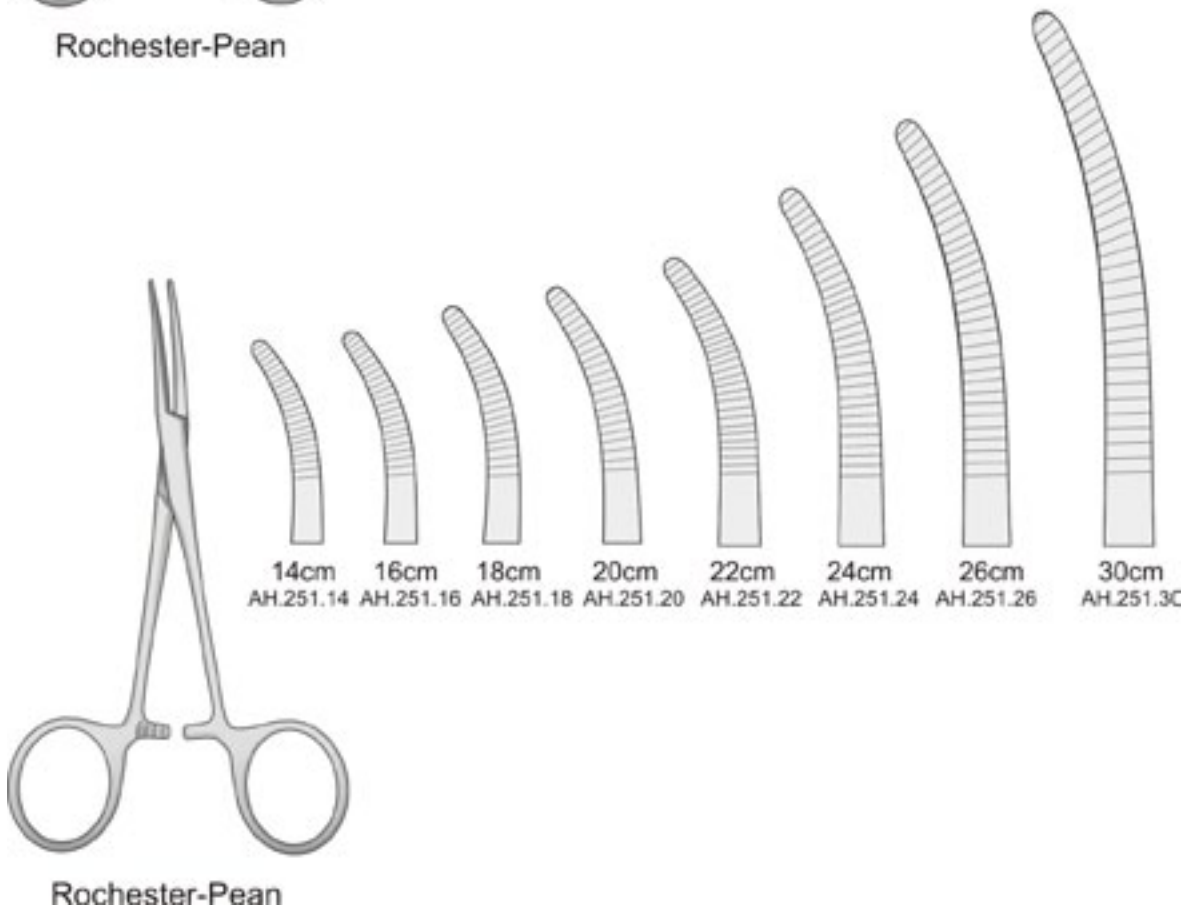
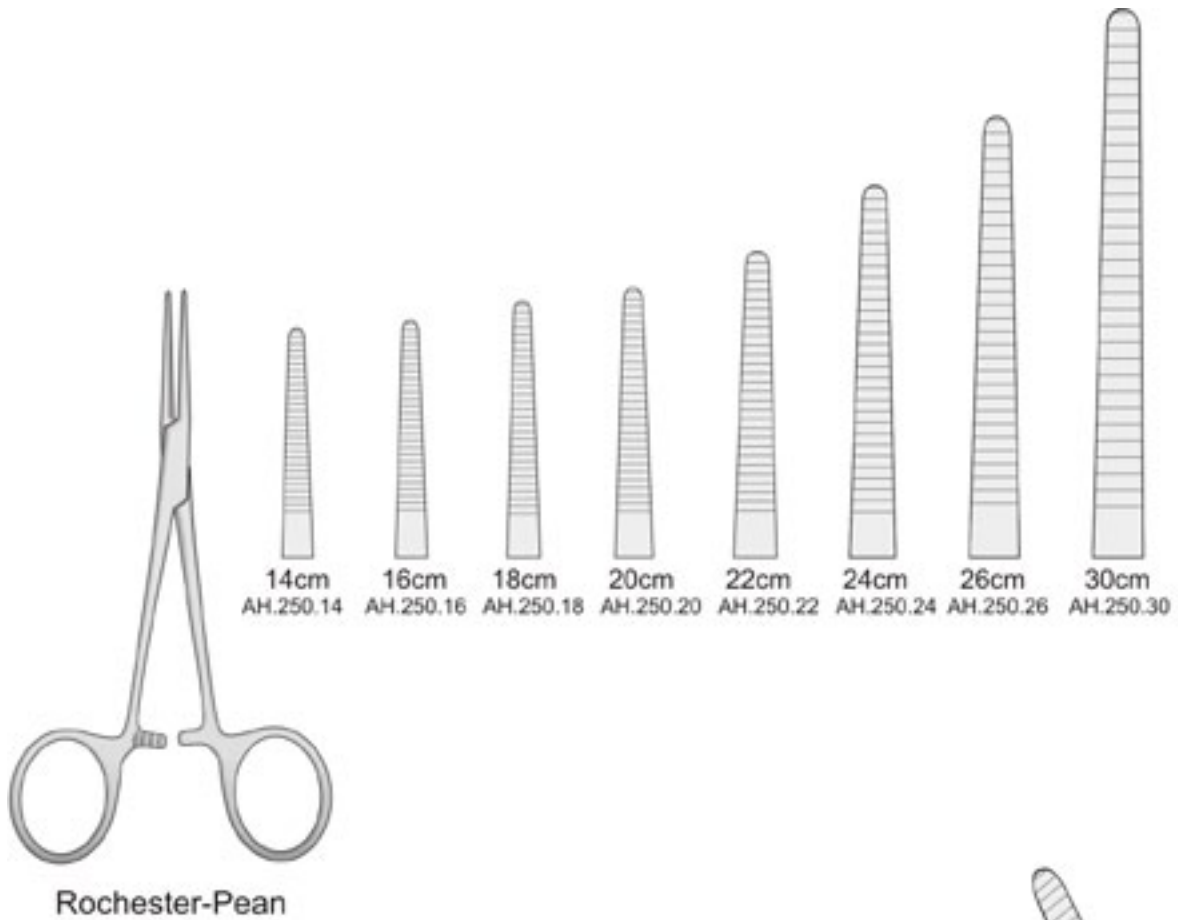

AH



Ochsner-Kocher

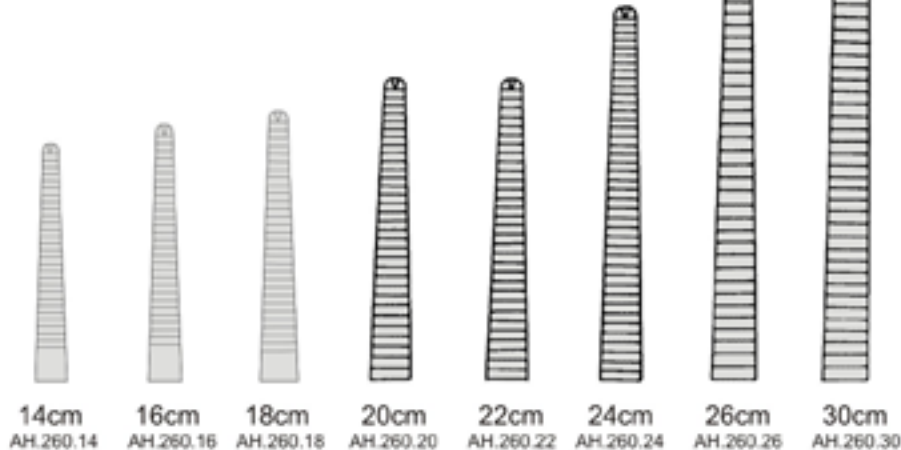

Ochsner-Kocher

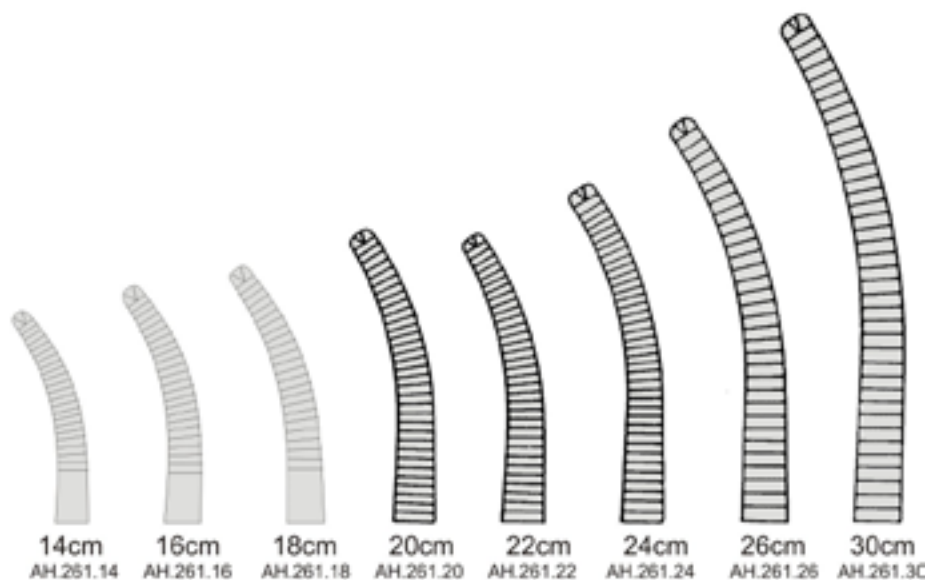

ARTERIENKLEMMEN
HEMOSTATIC FORCEPS

PINZAS HEMOSTÁTICAS
PINCES HÉMOSTATIQUES
PINZE EMOSTATICHE

AH



Craford

18cm AH.303.18
24cm AH.303.24



Meeker 27,5cm
AH.413.27



Wickström

21cm AH.355.21
24cm AH.355.24



Lawrence 27,5cm
AH.411.27



Overholt-Geissendoerfer

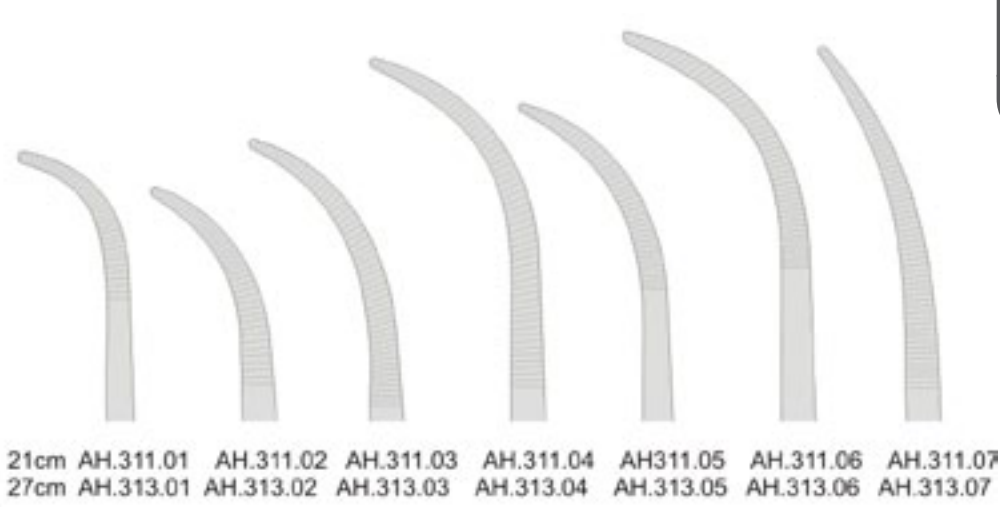

Rummel
23cm

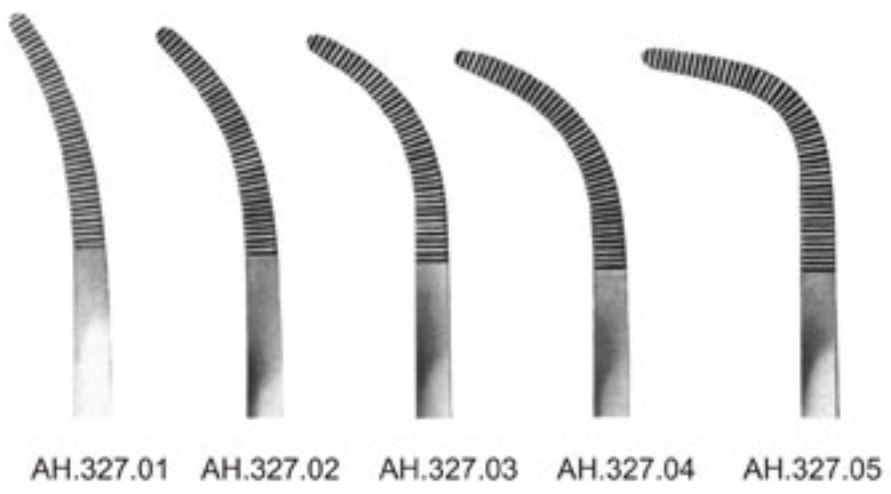

ARTERIENKLEMMEN
HEMOSTATIC FORCEPS

PINZAS HEMOSTÁTICAS
PINCES HÉMOSTATIQUES
PINZE EMOSTATICHE

AH



Gemini

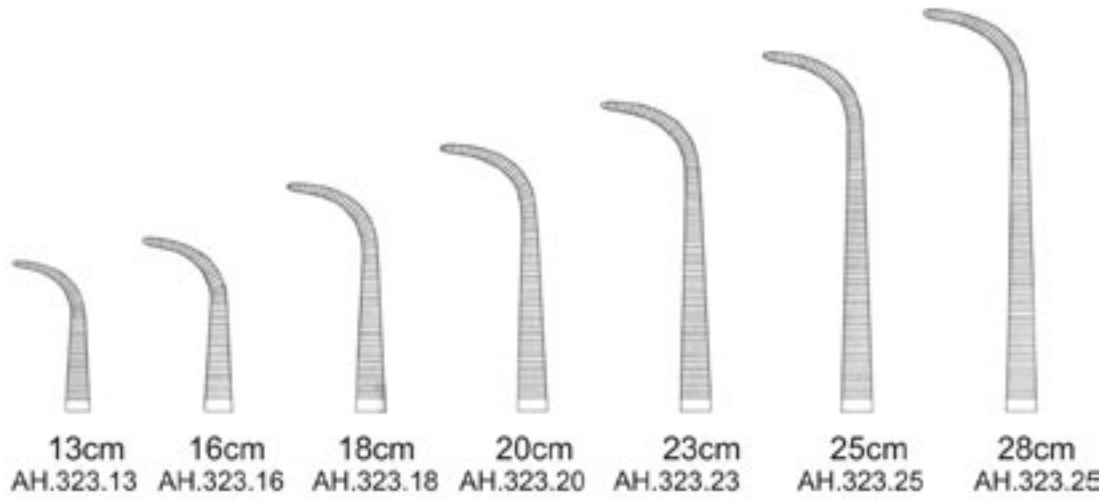

Mixer

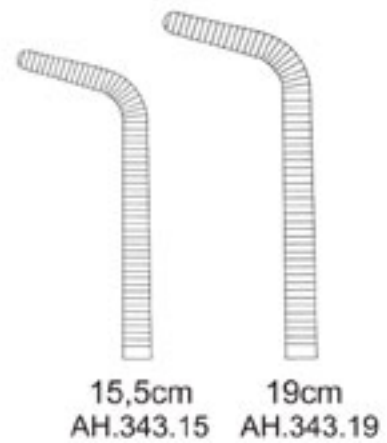



Ligaturklemme
28cm
AH.338.28

PERITONEUMKLEMMEN
PERITONAL CLAMP FORCEPS

PINZAS-CLAMPS PARA PERITONEO
PINCES-CLAMPS POUR LE PÉRITOINE
PINZE PER PERITONEO

AH





Höpfner 16cm
DA.520.16



T-Klemme 15cm
AH.908.15

GEWEBEFASSZANGEN
TISSUE SEIZING FORCEPS

PINZAS PARA COGER EL TEJIDOS
 PINCE POUR SAISIR LETISSU
 PINZE PER AFFERRARE IL TISSUTO

AI



Allis-Baby 12cm
 AI.100.12



Allis

	4 x 5 Zähne-techt-dents-dent	5 x 6 Zähne-techt-dents-dent
15cm	AI.102.15	AI.104.15
19cm		AI.104.19
25cm		AI.104.25



Allis-Atraumatisch
 15,5cm AI.110.16

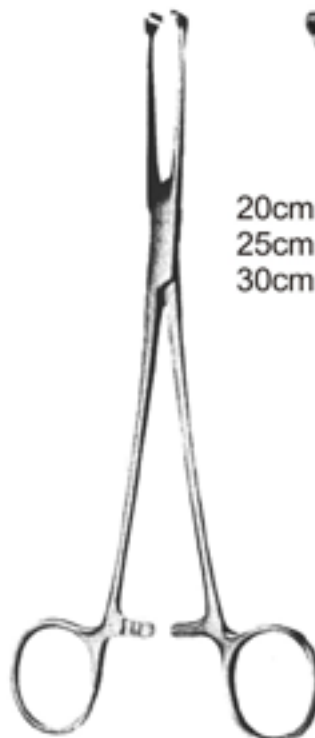

20cm = AI.110.20
 25cm = AI.110.25
 30cm = AI.110.30

Allis-Atraumatisch



Backhaus
AJ.110.09 = 9cm
AJ.110.11 = 11cm
AJ.110.13 = 13cm
AJ.110.15 = 15cm



Kugel und Pfanne
Ball and Socket
AJ.114.09 = 9cm
AJ.114.11 = 11cm
AJ.114.13 = 13cm



Lorna
AJ.118.10 = 10cm
AJ.118.13 = 13cm



Tohoku
AJ.128.10 = 10cm
AJ.128.13 = 13cm



Bernhard 16cm
AJ.122.16



Bertram 14cm
AJ.130.14

SCHLAUCHKLEMMEN
TUBING CLAMPS

PINZAS PARA TUBOS
PINCES PRESSE-TUBES
PINZE PER TUBI

AK



Schlauchklemme



14cm
AK.110.14



16cm
AK.110.16



18cm
AK.110.18



20cm
AK.110.20

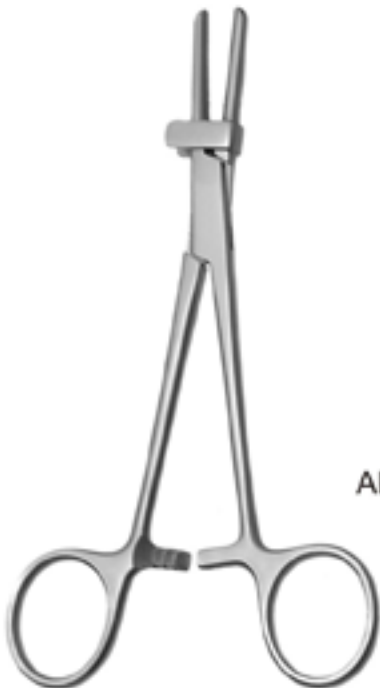

Schlauchklemme



15cm
AK.114.15



18cm
AK.114.18



20cm
AK.114.20

Metallrollen



Bülw-Gunar-Hey
18cm
AK.120.18

Teflonrollen



Aluminium
blau eloxiert

MEDE Rollenklemme
16cm
AK.122.16

KORNZANGEN
SPONGE AND DRESSING FORCEPS

PINZAS PARA PÓLIPOS Y VENDAJES
PINCES À TAMPONS
PINZE PER TAMPONI E MEDICATURA UTERINA

AL



Ulrich
AL.102.22 = 22cm
AL.102.25 = 25cm
AL.102.27 = 26,5cm

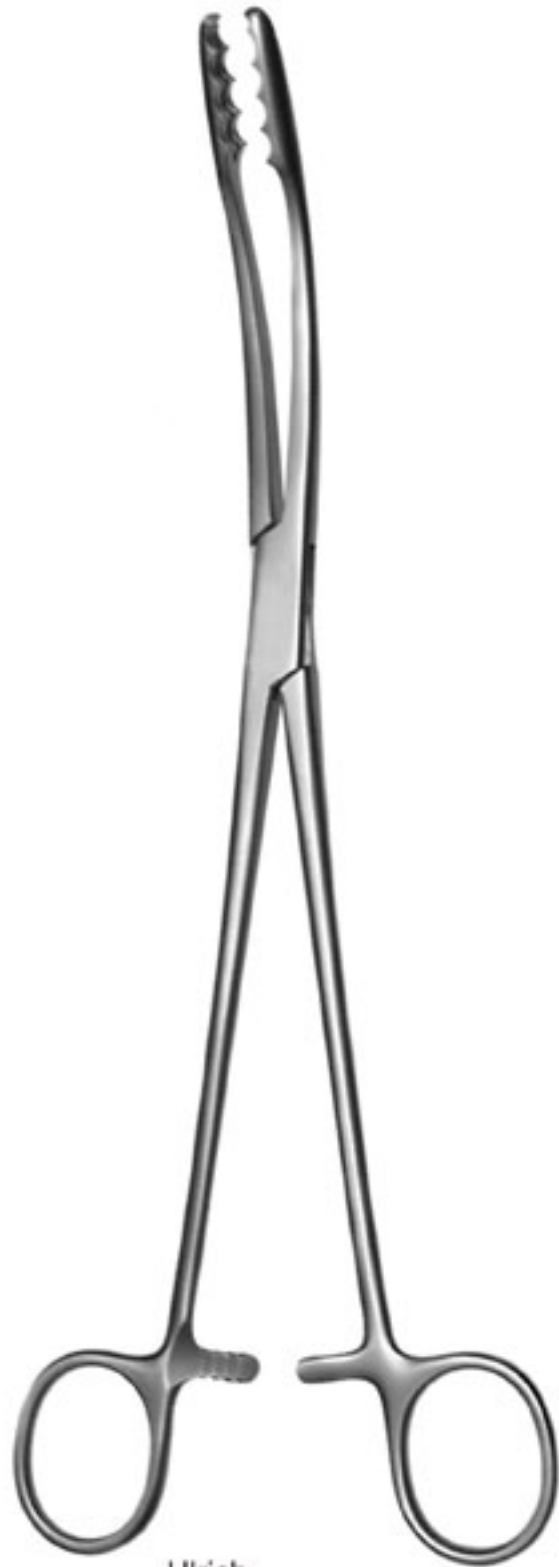

Ulrich
AL.103.22 = 22cm
AL.103.25 = 25cm
AL.103.27 = 26,5cm

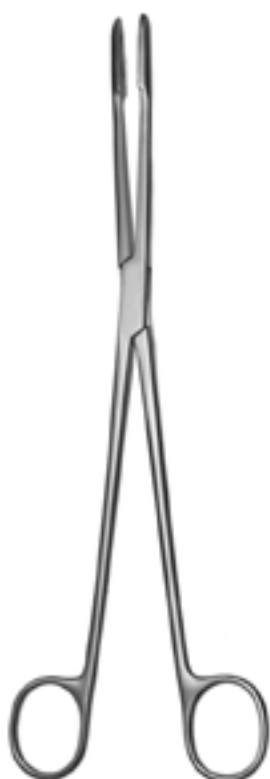

Gross-Maier
 20,0cm AL.120.20
 26,5cm AL.120.25



Gross-Maier
 AL.121.20
 AL.121.25



Gross-Maier
 AL.122.20
 AL.122.25



Gross-Maier
 AL.123.20
 AL.123.25

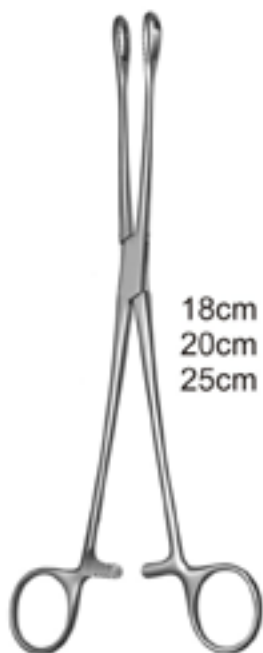

Foerster

18cm	AL.158.18	AL.160.18
20cm	AL.158.20	AL.160.20
25cm	AL.158.25	AL.160.25

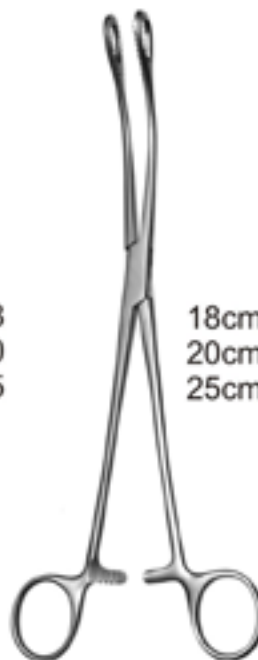

Foerster

18cm	AL.159.18	AL.161.18
20cm	AL.159.20	AL.161.20
25cm	AL.159.25	AL.161.25



KORNZANGEN
SPONGE AND DRESSING FORCEPS

PINZAS PARA PÓLIPOS Y VENDAJES
PINCES À TAMPONS
PINZE PER TAMPONI E MEDICATURA UTERINA

AL



Rampley

18cm
AL.176.18



25cm
AL.176.25



Maier 24,5cm

AL.178.24

AL.179.24

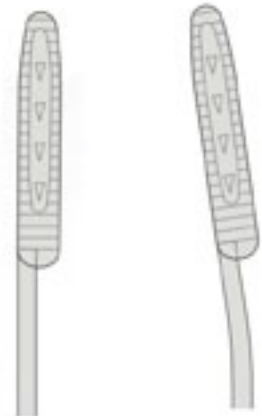



AL.190.21 = 21cm
AL.190.25 = 25cm
AL.190.32 = 31cm

Kappenzange

AM

Flexibel - flexible - flexible -flexibles - flessibile



AM.064.01 AM.064.02 AM.064.03 AM.064.04 AM.065.01 AM.065.02 AM065.03 AM.065.04

16cm

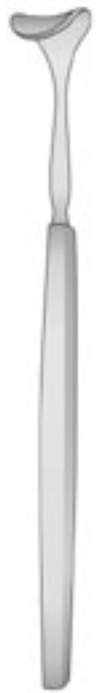

Desmarres
16cm



Desmarres
16cm
AM.853.16



Senn-Green
15cm



WUNDHAKEN
RETRACTORS

SEPARADORES
ECARTEURS
DIVARICATORI

AM



AM.080.01 AM.080.02 AM.080.03 AM.080.04 AM.081.01 AM.081.02 AM.081.03 AM.081.04

16cm

AM



Lahey 19,5cm
 AM.093.19

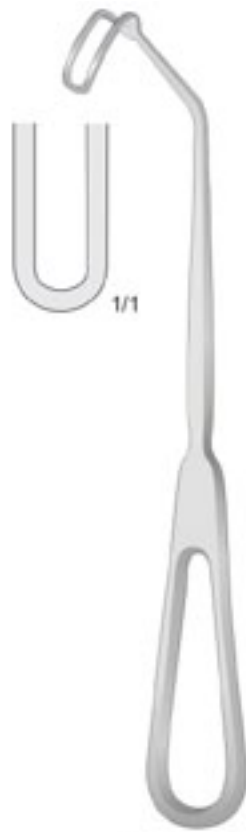

Cushing 20cm
 AM.093.20



Wassmund 20cm
 AM.131.02

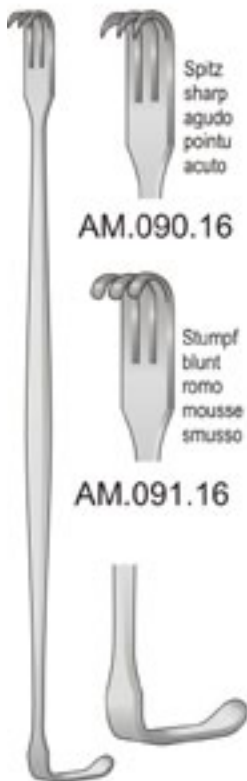

Senn-Mueller 16cm

AM.090.16

AM.091.16



Ragnell 15cm
 AM.088.15



Ragnell-Davis 14cm
 AM.088.14

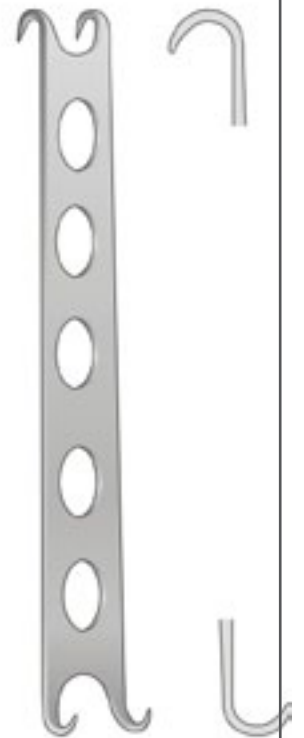

Converse 12cm
 AM.088.92

WUNDHAKEN
RETRACTORS

SEPARADORES
ECARTEURS
DIVARICATORI

AM



Gil-Vernet
28cm



AM.106.09

AM.106.13

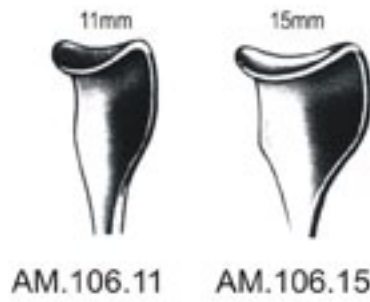

AM.106.11

AM.106.15



AM.106.18



Cushing 25cm



AM.103.11



AM.103.13



AM.103.15



Cushing-Kocher
18cm



AM.099.18



Kocher 22cm
AM.120.01



Kocher 22cm
AM.121.01



Kocher 22cm
AM.122.01



AM.115.01

Volkman 21,5cm



AM.116.01

Volkman 21,5cm

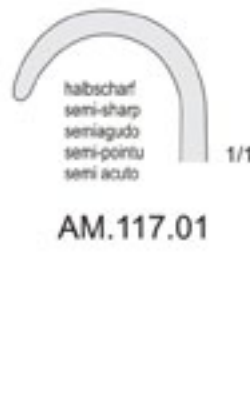

AM.117.01



24,5cm
AM.116.11

**WUNDHAKEN
RETRACTORS**

SEPARADORES
ECARTEURS
DIVARICATORI

AM



Volkmann 21,5cm



scharf
sharp
agudo
pointu
acuto

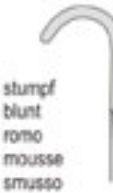

stumpf
blunt
romo
mousse
smusso



halbscharf
semi-sharp
semi-agudo
semi-pointu
semi-acuto



Kocher 22cm



scharf
sharp
agudo
pointu
acuto



stumpf
blunt
romo
mousse
smusso



AM.115.02



AM.115.03



AM.115.04



AM.115.06



AM.116.02



AM.116.03



AM.116.04



AM.116.06



AM.117.02



AM.117.03



AM.117.04



AM.117.06



AM.120.02



AM.120.03



AM.120.04



AM.120.06



AM.121.02



AM.121.03



AM.121.04



AM.121.06



Israel
25cm



40x40mm

AM.138.04



45x50mm

AM.138.05

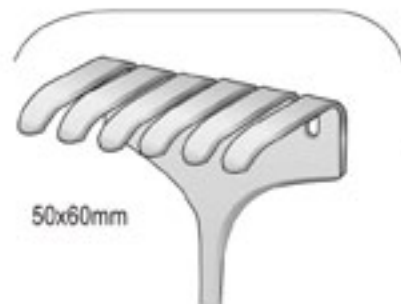

50x60mm

AM.138.06

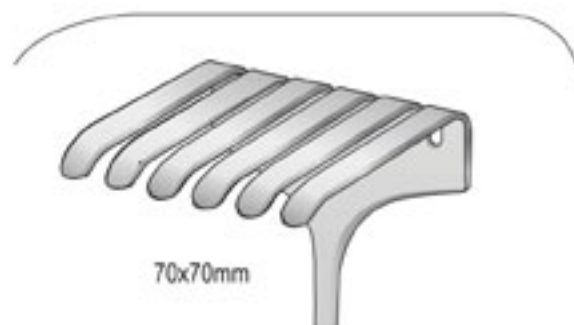

70x70mm

AM.139.06

**WUNDHAKEN
RETRACTORS**

SEPARADORES
ECARTEURS
DIVARICATORI

AM



Langenbeck 22cm

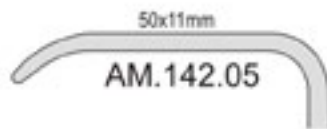
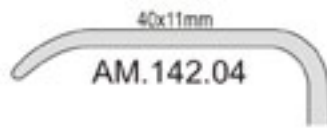
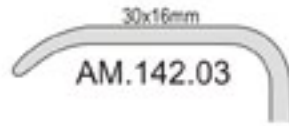

Langenbeck 21cm

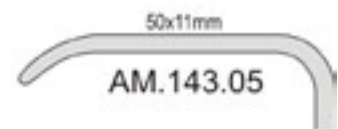
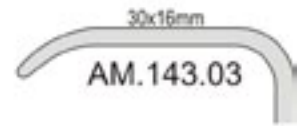

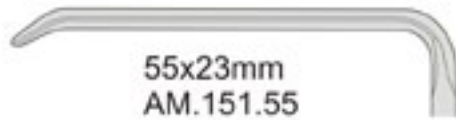
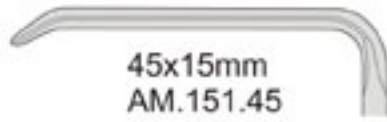

Sauerbruch 22,5cm

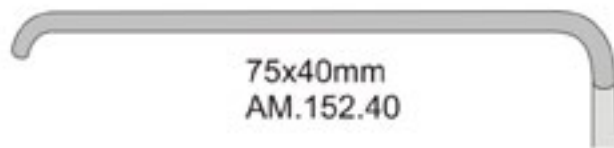
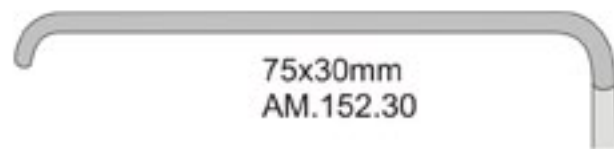
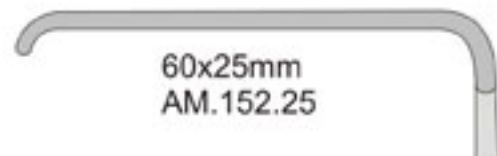
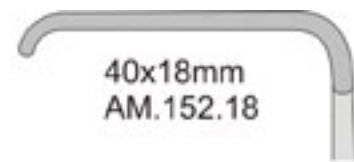

Kocher 23cm

WUNDHAKEN
RETRACTORS

SEPARADORES
ECARTEURS
DIVARICATORI

AM



Kocher Langenbeck
21,5cm

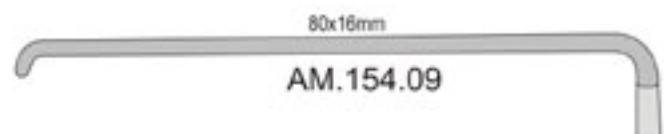
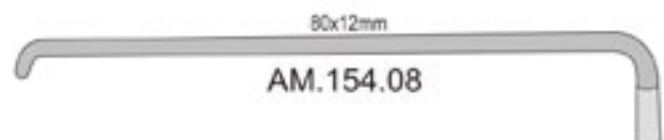
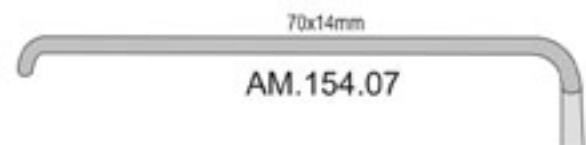
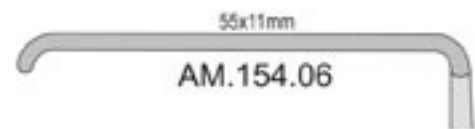
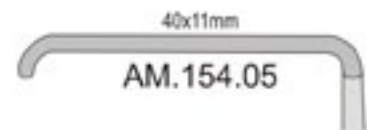
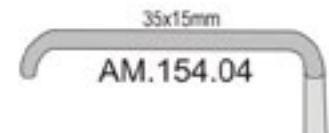
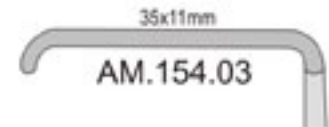
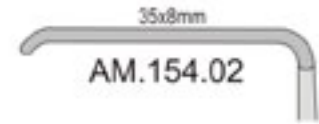
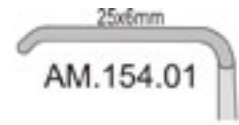



Obwegeser
22cm



Obwegeser
22cm

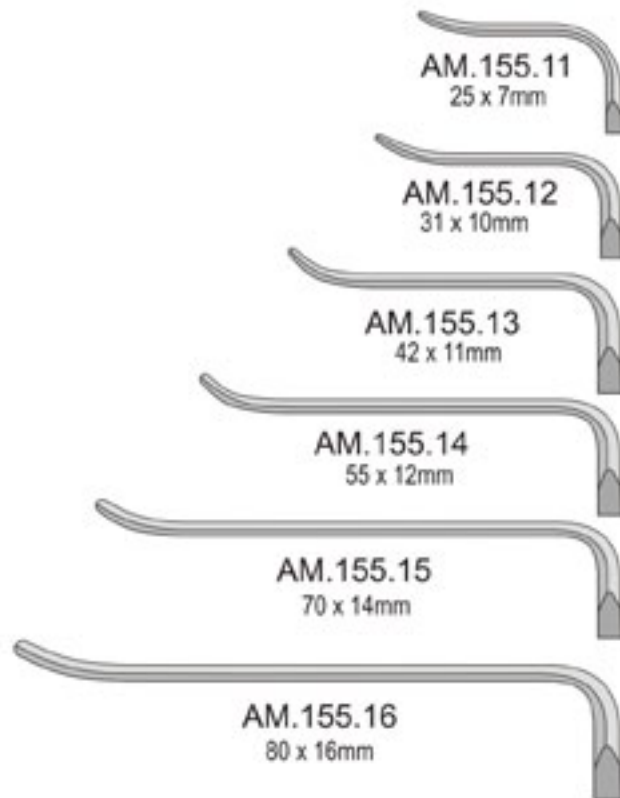
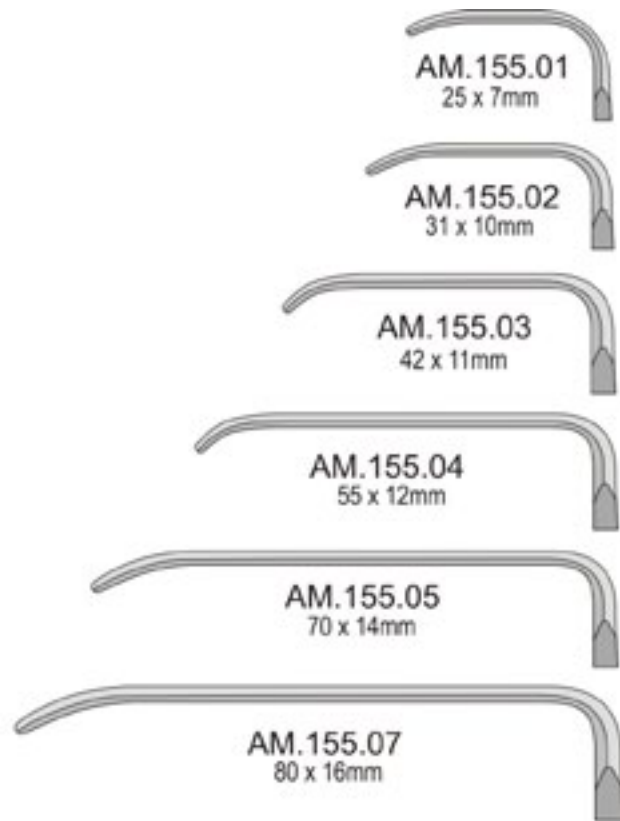

**WUNDHAKEN
RETRACTORS**

SEPARADORES
ECARTEURS
DIVARICATORI

AM



14x17mm
21,5cm

AM.163.01



Middeldorpf



20x22mm
22cm

AM.163.02



26x30mm
23,5cm

AM.163.03



52 x 16 mm

AM.166.01



76 x 25 mm

AM.166.02



89 x 50 mm

AM.166.03

**Meyerding
22,5cm**

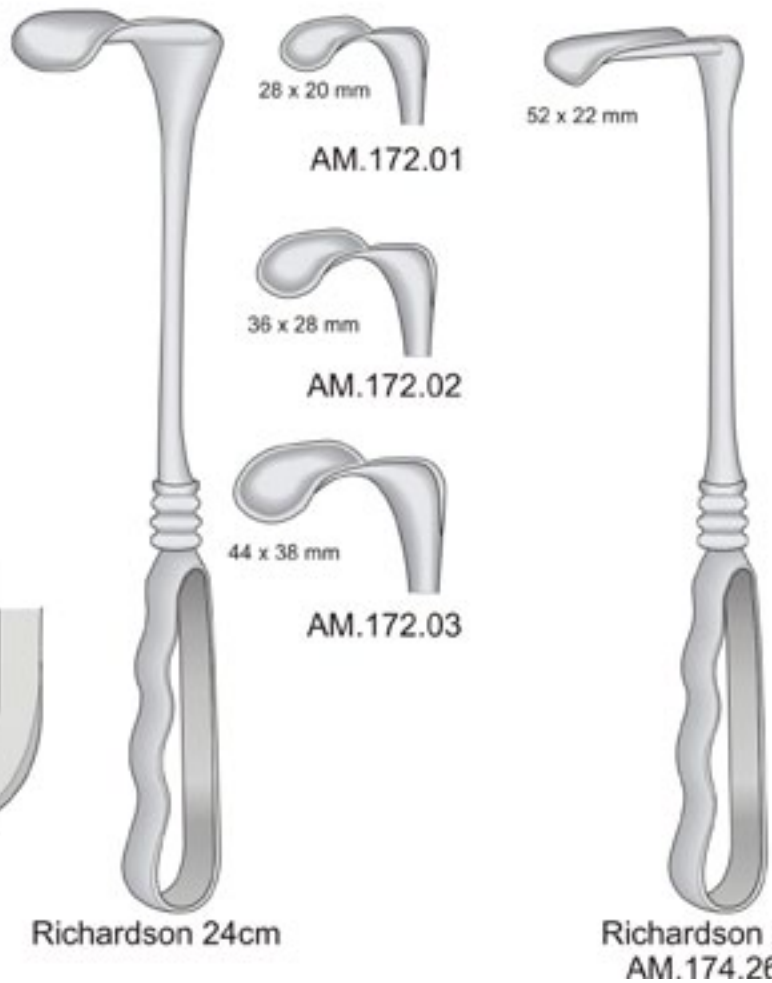
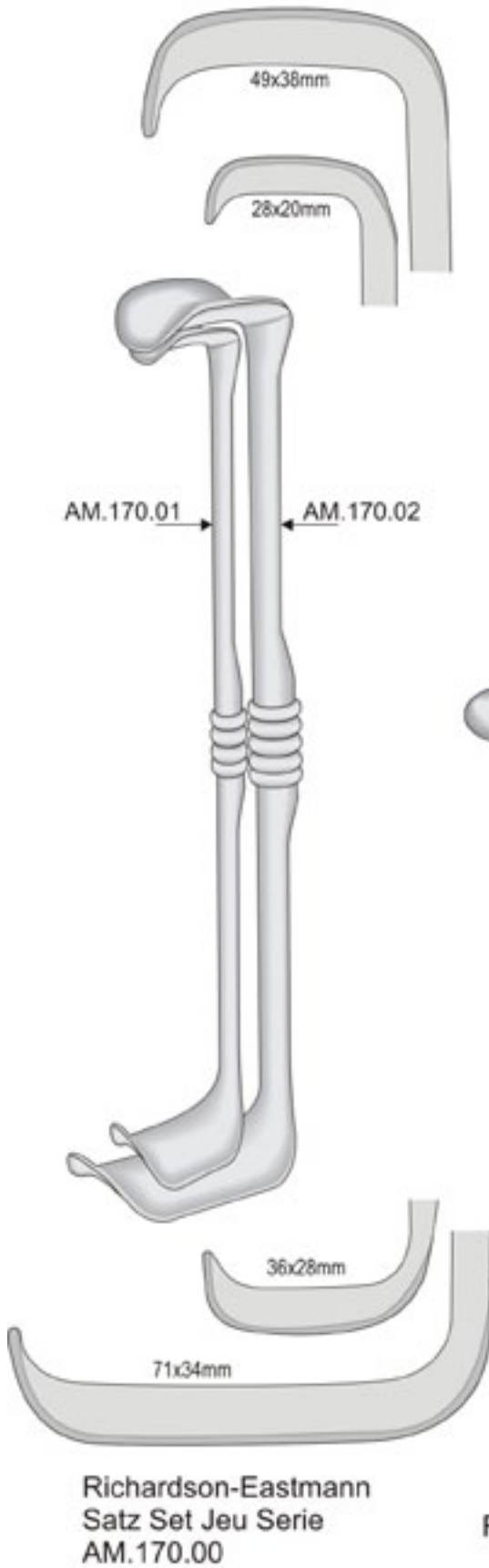

**WUNDHAKEN
RETRACTORS**

SEPARADORES
ECARTEURS
DIVARICATORI

AM

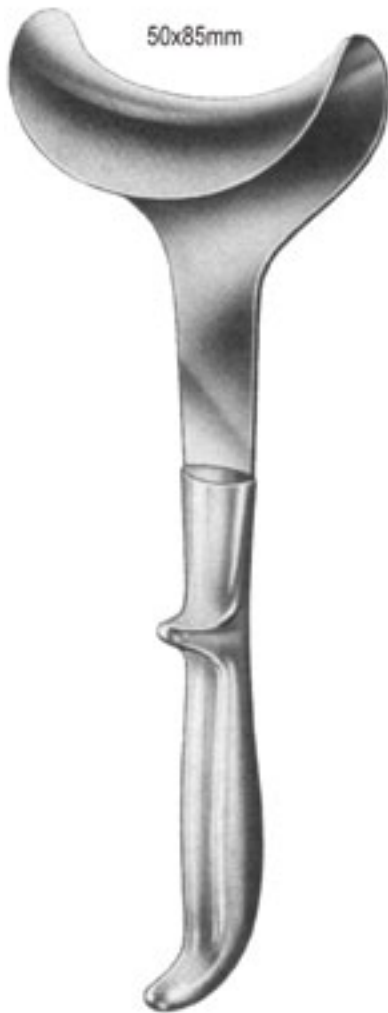

50x85mm

Doyen 25cm
AM.194.25



25x75mm
AM.196.75

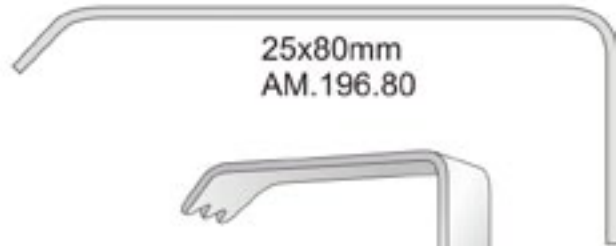

25x80mm
AM.196.80



Hibbs 24cm



Kocher 25cm

AM.202.01 = 80x45mm

AM.202.02 = 80x55mm

AM.202.03 = 80x65mm

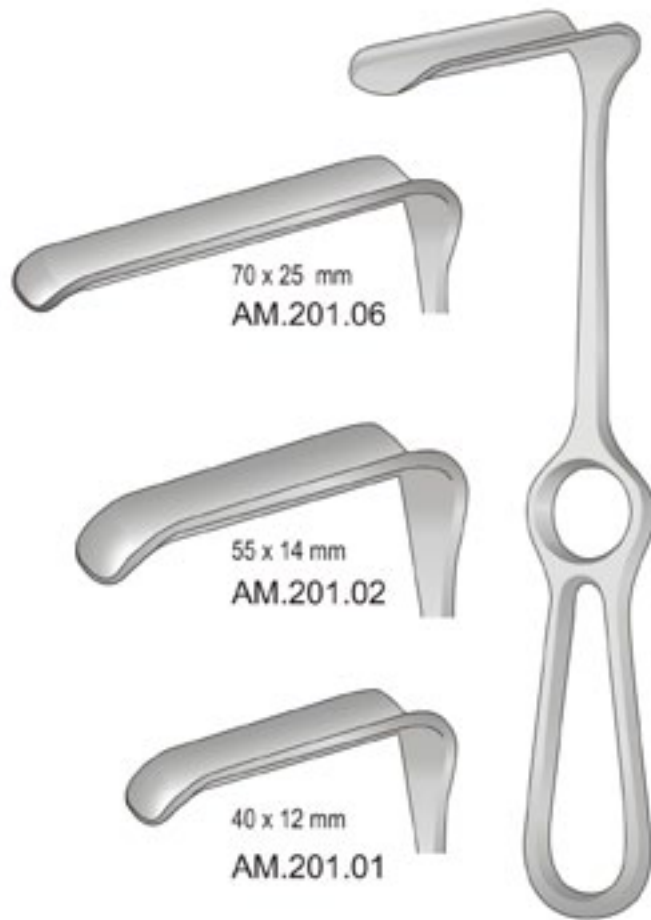

70 x 25 mm
AM.201.06

55 x 14 mm
AM.201.02

40 x 12 mm
AM.201.01



Dockhorr
21,5cm

WUNDHAKEN
RETRACTORS

SEPARADORES
ECARTEURS
DIVARICATORI

AM





WUNDHAKEN
RETRACTORS

SEPARADORES
ECARTEURS
DIVARICATORI

AM

Lungenspatel
Lung Spatulas
Espatulas pulmonares
Spatules pulmonaires
Spatole per polmone



Allison



45mm

30cm
CF.050.30



60mm

32cm
CF.050.32



Davidson
AM.216.01



Davidson
AM.216.02



WUNDHAKEN
RETRACTORS

SEPARADORES
ECARTEURS
DIVARICATORI

AM

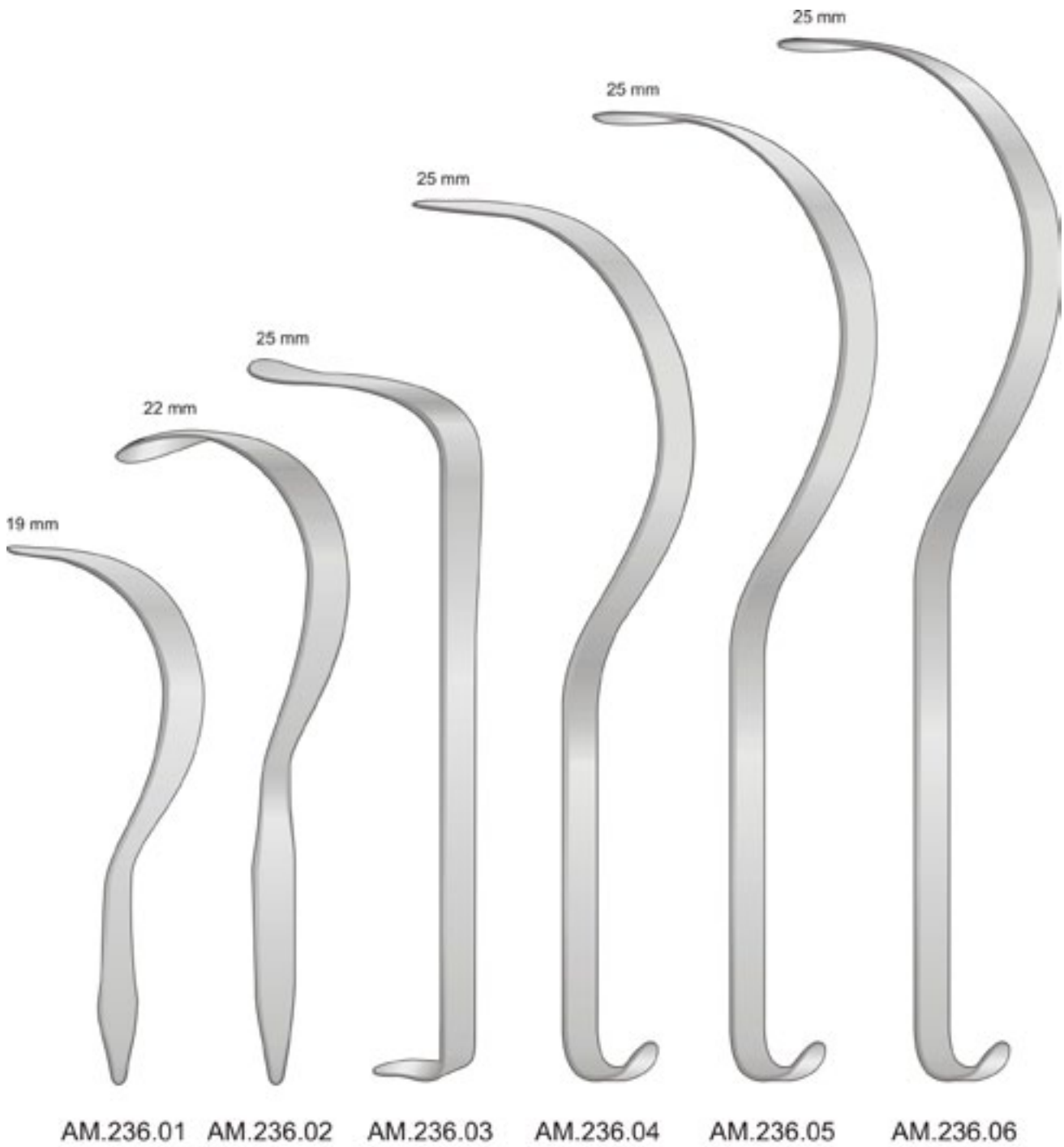

Deaver

38 mm



AM.236.07

50 mm



AM.236.08

75 mm



AM.236.09

Deaver

WUNDHAKEN
RETRACTORS

SEPARADORES
ECARTEURS
DIVARICATORI

AM

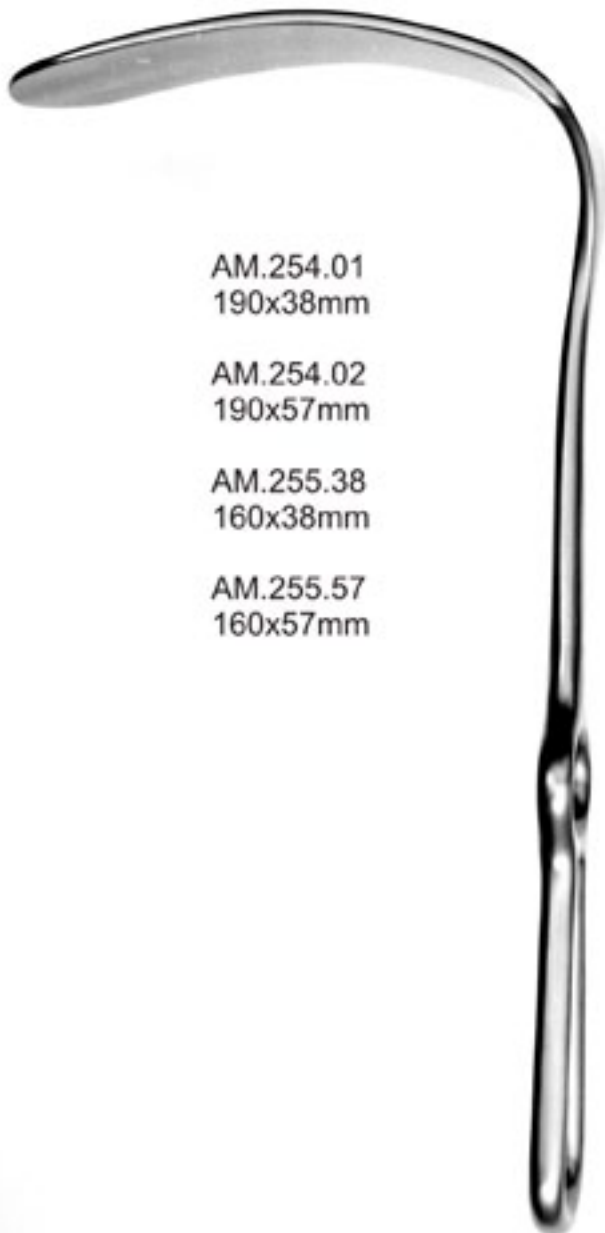

AM.254.01
190x38mm

AM.254.02
190x57mm

AM.255.38
160x38mm

AM.255.57
160x57mm

Kelly 27cm

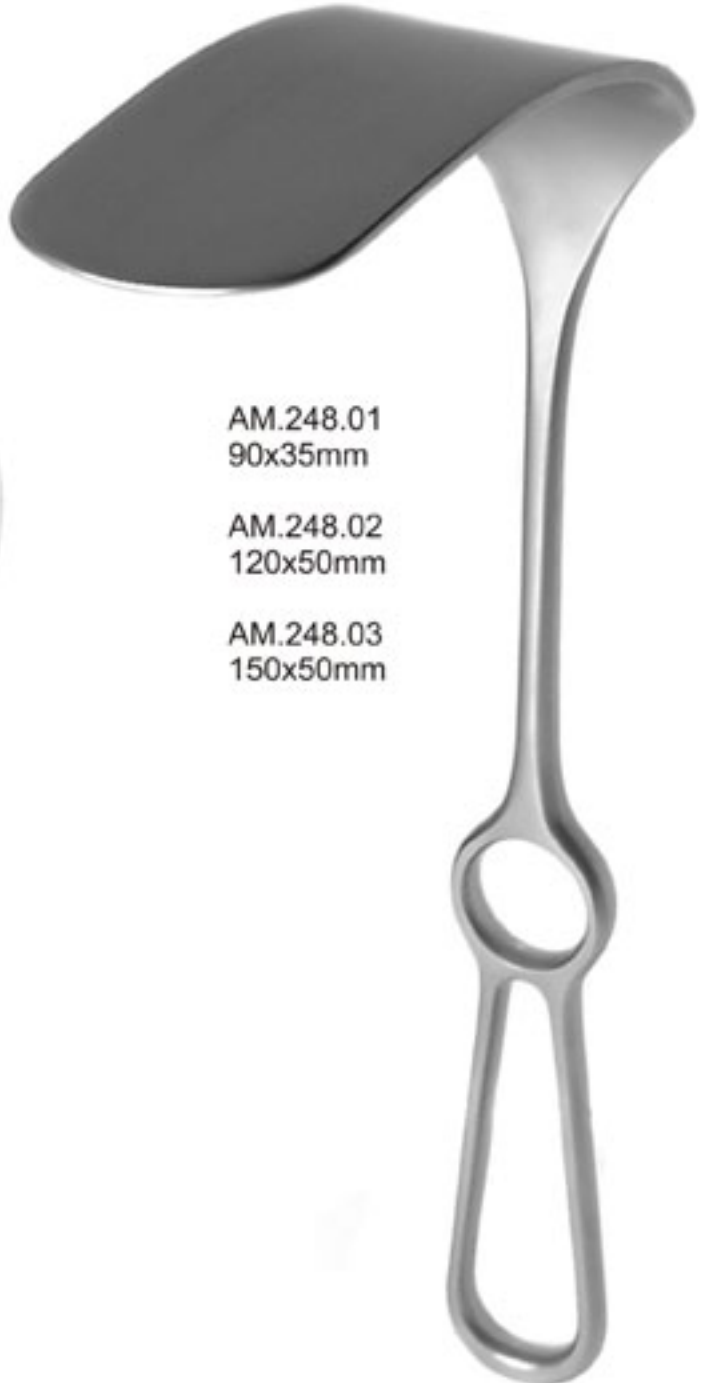

AM.248.01
90x35mm

AM.248.02
120x50mm

AM.248.03
150x50mm

Mikulicz 26cm

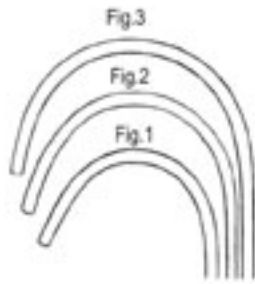

Fig.1 = AM.280.01
 Fig.2 = AM.280.02
 Fig.3 = AM.280.03



Roux
 Satz/Set/Juego/Jeu de
 AM.280.00



AM.281.01

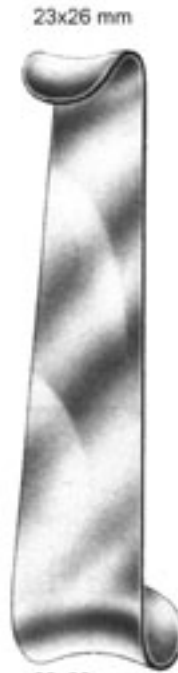

AM.281.02



AM.281.03



Farabeuf 12cm
 AM.284.12



Farabeuf 15cm
 AM.284.15

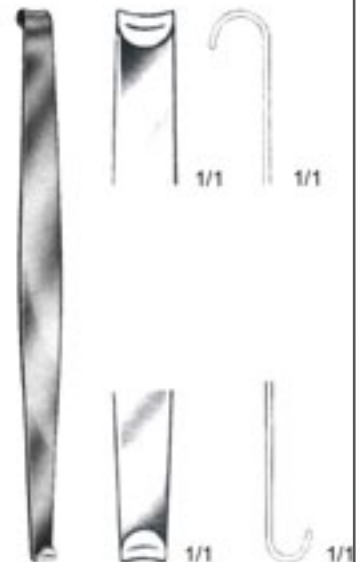

Mini-Roux
 14cm
 AM.288.06

**WUNDHAKEN
RETRACTORS**

SEPARADORES
ECARTEURS
DIVARICATORI

AM



Baby-Roux
13cm
AM.289.13



Roux
16cm
AM.286.16



Roux
18,5cm
AM.289.19



Parker
13,5cm
AM.292.13



Parker
18cm
AM.292.18



Parker-Mott
16cm
AM.296.00



Mathieu
20cm
AM.298.00



Parker-Langenbeck
21cm
AM.300.00



Goelet
19cm
AM.302.00

WUNDSPREIZER
SELF-RETAINING RETRACTORS

SEPARADORES AUTOSTÁTICOS
 ECARTEURS
 DIVARICATORI

AM



Finsen



5cm
 AM.401.05

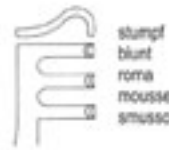

5cm
 AM.402.05



7cm
 AM.401.07

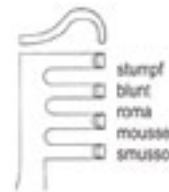

7cm
 AM.402.07



Finsen 7cm



AM.403.07



AM.404.07



Holzheimer
 10cm

scharf
 sharp
 agudo
 pointu
 acuto

AM.420.10

stumpf
 blunt
 roma
 mousse
 smusso

AM.421.10



ALM
 7cm



scharf
 sharp
 agudo
 pointu
 acuto

AM.414.07



stumpf
 blunt
 roma
 mousse
 smusso

AM.415.07

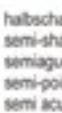

halbscharf
 semi-sharp
 semi-agudo
 semi-pointu
 semi-acuto

AM.416.07



ALM
 10cm



scharf
 sharp
 agudo
 pointu
 acuto

AM.414.10



stumpf
 blunt
 roma
 mousse
 smusso

AM.415.10

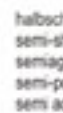

halbscharf
 semi-sharp
 semi-agudo
 semi-pointu
 semi-acuto

AM.416.10

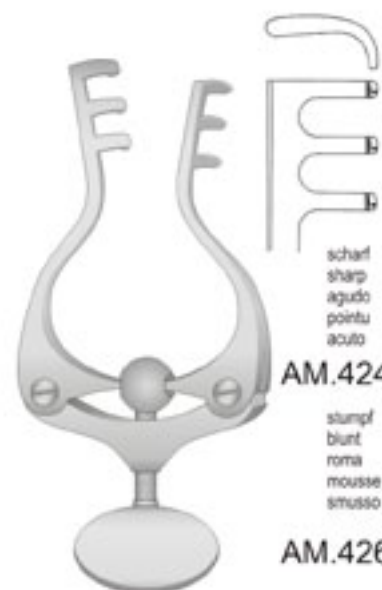

Jansen
 10cm

scharf
 sharp
 agudo
 pointu
 acuto

AM.424.1C

stumpf
 blunt
 roma
 mousse
 smusso

AM.426.1C



Weitlaner 10,5cm

spitz	stumpf
sharp	blunt
agudo	roma
pointu	mousse
acuto	smusso

AM.442.10 AM.443.10



Weitlaner

spitz	stumpf
sharp	blunt
agudo	roma
pointu	mousse
acuto	smusso

14cm	AM.442.14	AM.443.14
16cm	AM.442.16	AM.443.16
20cm	AM.442.20	AM.443.20



Plester 13cm

spitz	stumpf
sharp	blunt
agudo	roma
pointu	mousse
acuto	smusso

AM.452.13 AM.453.13



Plester 11cm
 AM.456.11



Plester 11cm
 AM.457.11

WUNDSPREIZER
SELF-RETAINING RETRACTORS

SEPARADORES AUTOSTÁTICOS
 ECARTEURS
 DIVARICATORI

AM



Henley 16,5cm

spitz
 sharp
 agudo
 pointu
 acuto



AM.462.16

stumpf
 blunt
 roma
 mousse
 smusso



AM.463.16

16x19mm



AM.465.19

16x25mm



AM.465.25

16x32mm



AM.465.32

Sperrer komplett mit je 1 Mittelvalve
 Henley Spreader complet with 1 each center blade
 separador Henley cpl.con 1 de c.u.valva central
 chaque écarteur cpl.avec 3 valves centrales AM.465.19-32
 Divaricatori con valve centrali AM.465.19-32



Gelpi-Loktite 13cm
AM.490.13



Gelpi-Seiletz 15cm
AM.492.15



Gelpi-Loktite 18cm
AM.490.18



Gelpi-Loktite 18cm
AM.491.18

BAUDECKENHALTER
ABDOMINAL RETRACTOR

SEPARADORES ABDOMINALES
ECARTEURS À PARI ABDOMINALE
DIVARICATORI ADDOMINALI

AM

Rahmen zusammenlegbar
with folding frame
cadre pliable
cuadro plegable
Divaricatore solo a chiusura pieghevole

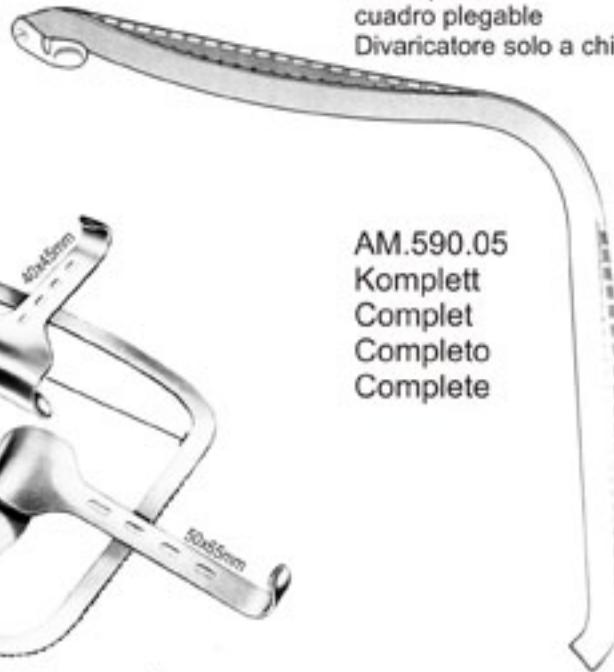

AM.590.05
Komplett
Complet
Completo
Complete



AM.590.00
Komplett
Complet
Completo
Complete

Kirschner Rahmen starr
-rigid frame
-cuadro fijo
-cadre bombé fixe
-Divaricatore solo fisso



Kirschner
AM.590.40 = 40x55mm
AM.590.50 = 50x65mm



Kirschner
AM.590.60 = 60x85mm
AM.590.65 = 65x80mm
AM.590.78 = 78x65mm



Kirschner
AM.590.80 = 80x80mm
AM.590.84 = 80x90mm



Kirschner
AM.590.88 = 90x65mm
AM.590.90 = 90x90mm
AM.590.92 = 108x42mm



Stille-Gippschere
 AO.100.23 = 23cm
 AO.100.26 = 26cm
 AO.100.37 = 37cm



Einhandmodell
 24cm
 AO.101.24



Henning
 28,0cm
 AO.210.28



USA-Modell
 AO.220.23



Wolf
 AO.230.18 = 18cm
 AO.230.24 = 24cm



Haglund
 28cm
 AO.212.18

NAGELSCHEREN
NAIL SCISSORS

TIJERAS
CISEAUX
FORBICI

AP

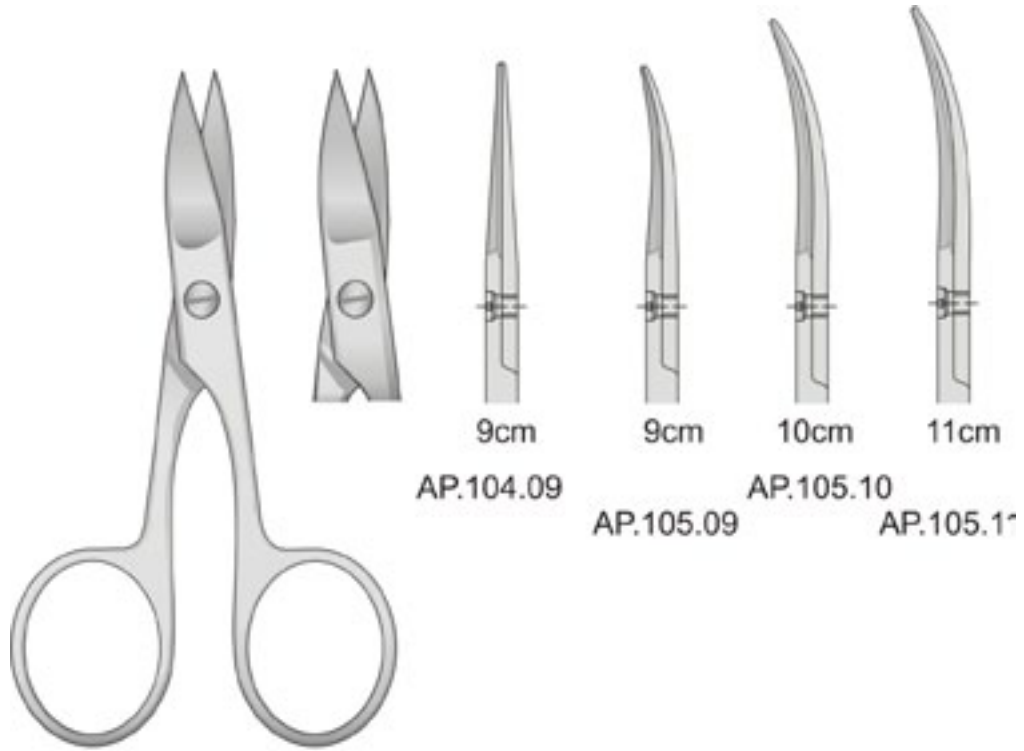

TIJERAS
CISEAUX
FORBICI

NAGELSCHEREN NAIL SCISSORS

AP



Schwesterbesteck

Article No.	
AP.100.03	3 Teilig



Nagelschere

Article No.	Size
AP.107.09	9,0cm



Baby Nagelschere

Article No.	Size
AP.111.08	8,5cm



Nagelzange ergonomisch

Article No.	Size
AP.115.18	18,0cm



NAGELZANGEN
NAIL NIPPERS

PINZAS CONTAUNAS
PINCES À ONGLES
TRONCHESINE PER UNGHIE

AP



13cm
AP.118.13



Kopfschneider

Article No.	Size
AP.120.14	14,0cm



Nagelzange
22mm Schneide

Article No.	Size
AP.124.14	14,0cm
AP.124.16	16,0cm



12cm
AP.136.12



AP.140.11 = 11cm
AP.140.13 = 13cm



Nagelzange doppeltüber-
 setzt - klein

Article No.	Size
APZ.128.12	12,0cm



Nagelzange doppeltüber-
 setzt - gebogen

Article No.	Size
APZ.128.15	15,0cm



Nagelzange doppeltüber-
 setzt - gerade

Article No.	Size
APZ.128.55	15,0cm



Nagelzange doppeltübersetzt -
 kopfschneider

Article No.	Size
AP.130.15	15,0cm

NAGELZANGEN NAIL NIPPERS

PINZAS CONTAUNAS
PINCES À ONGLES
TRONCHESINE PER UNGHIE

AP



Nagelzange

Article No.	Size
APZ.124.14	14,0cm



Für Diabetiker
For Diabetic

Nagelzange - kopfschneiden

Article No.	Size
AP.125.14	14,0cm



Nagelhautzange

Article No.	Size
AP.153.10	10,0cm

LIMA DE U'NAS
LIME À ONGLES
LIMA PER UNGHIE

NAGELFEILE
NAIL FILE

AP



Nagelfeile

Article No.	Size
AP.180.10	10,0cm



Safir Nagelfeile

Article No.	Size
AP.185.13	13,0cm



in zwei Farben
two differend colors

Glasfeile

Article No.	Size
AP.188.04	13,0cm

KEYES HAUTSTANZEN
DERAML PUNCHES

CUTANEOUS PUNCHES
TRÉPANOS CUTÁNEOS
TRÉPANS CUTANÉS

AP



AP.340.00

Satz komplett
Set complete
Juego completo
Jeu complét



Einsatz allein
AP.340.52 =2mm
AP.340.53 =3mm
AP.340.54 =4mm
AP.340.55 =5mm
AP.340.56 =6mm
AP.340.57 =7mm



Griff allein
Handle only
AP.340.50



Keyes
9,5cm

AP.340.02 =2mm
AP.340.03 =3mm
AP.340.04 =4mm
AP.340.05 =5mm
AP.340.06 =6mm
AP.340.07 =7mm
AP.340.08 =8mm



Keyes 90°
8,5cm

AP.341.02 =2mm
AP.341.03 =3mm
AP.341.04 =4mm
AP.341.05 =5mm
AP.341.06 =6mm
AP.341.07 =7mm
AP.341.08 =8mm



17cm
AP.404.17

Sägeblatt alleine
Saw blade only



AP.404.99

Fingerringsägen
Finger Ring Saw
Sierras para cortar anillos
Scies pour bagues
Seghe per anelli



16cm
AP.405.16

Sägeblatt alleine
Saw blade only



AP.405.99

AP



Radolf
13cm
AP.410.13



Nagelausreißzange
14,5cm
AP.412.14

Finger und Zehenkompressorium
mit Metallband
Torniquet for fingers and toes,
with metal strap



Feldheim
10cm
AP.420.10



Zirkel

Osher
0-10mm rostfrei/stainless
AR.301.01



Jameson
0-80mm
AR.301.02 rostfrei/stainless
AR.302.02C verchromt/chrome

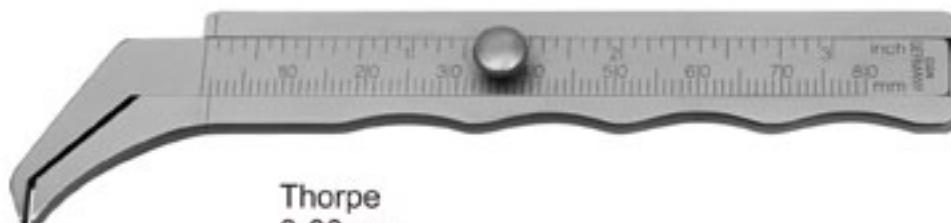

Thorpe
0-80mm
AR.301.03 rostfrei/stainless
AR.302.03C verchromt/chrome



Townley
0-10mm rostfrei/stainless
AR.301.05

AR

Dynamometer
Dynamometer
Dinamómetro
Dynamomètre
Dinamometro

für Erwachsene
for adults
para adultos p
pour adultes
per adulti



Collin
AR.320.01

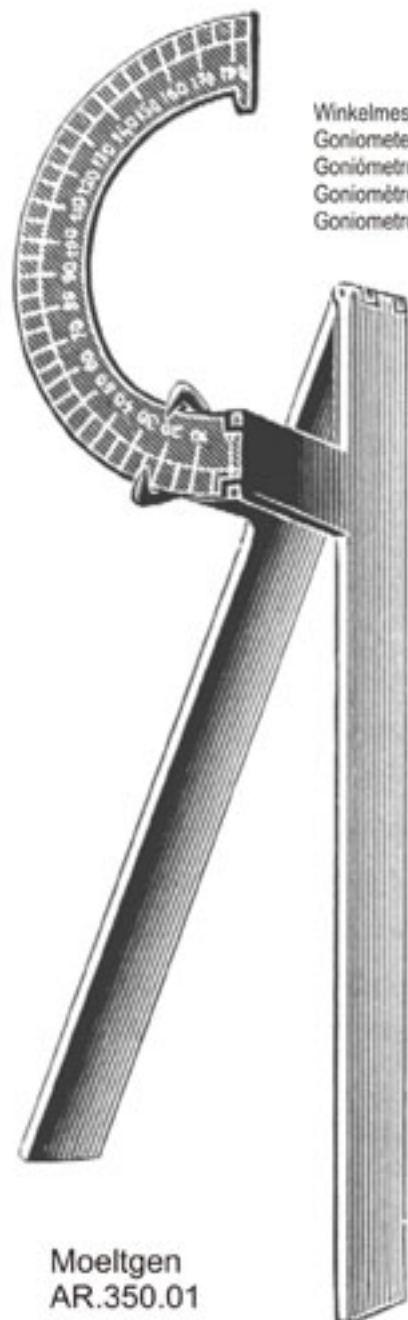

Winkelmesser
Goniometer
Goniómetro
Goniomètre
Goniometro

Moeltgen
AR.350.01



Ø 4,5 mm Ø 3 mm Ø 1,75 mm

Universaltrokar mit 3 Ausätzen
Universal Trocar with 3 tips
Trocar universal con 3 puntas
Trocart universal avec 3 empouts
Trequatri universale con 3 punte

AS.100.03

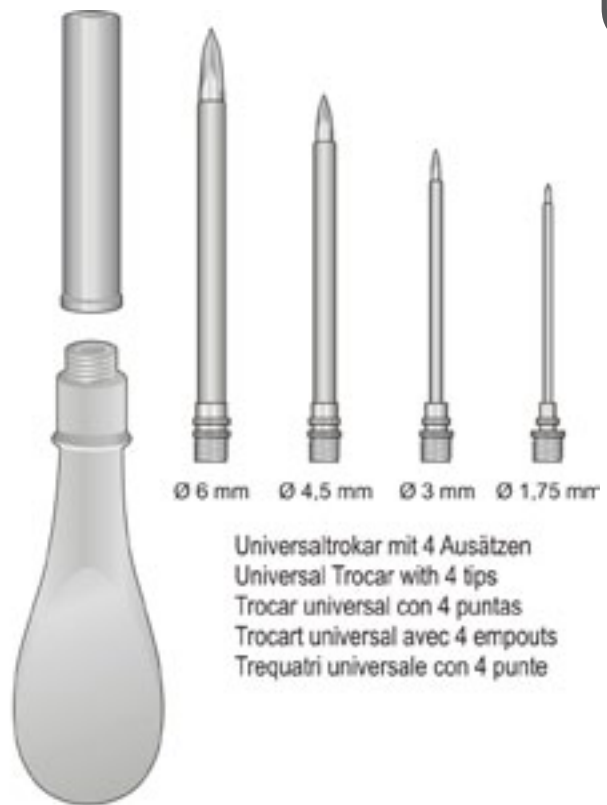

Ø 6 mm Ø 4,5 mm Ø 3 mm Ø 1,75 mm

Universaltrokar mit 4 Ausätzen
Universal Trocar with 4 tips
Trocar universal con 4 puntas
Trocart universal avec 4 empouts
Trequatri universale con 4 punte

AS.100.04

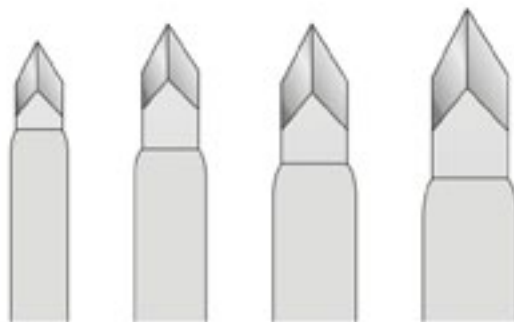
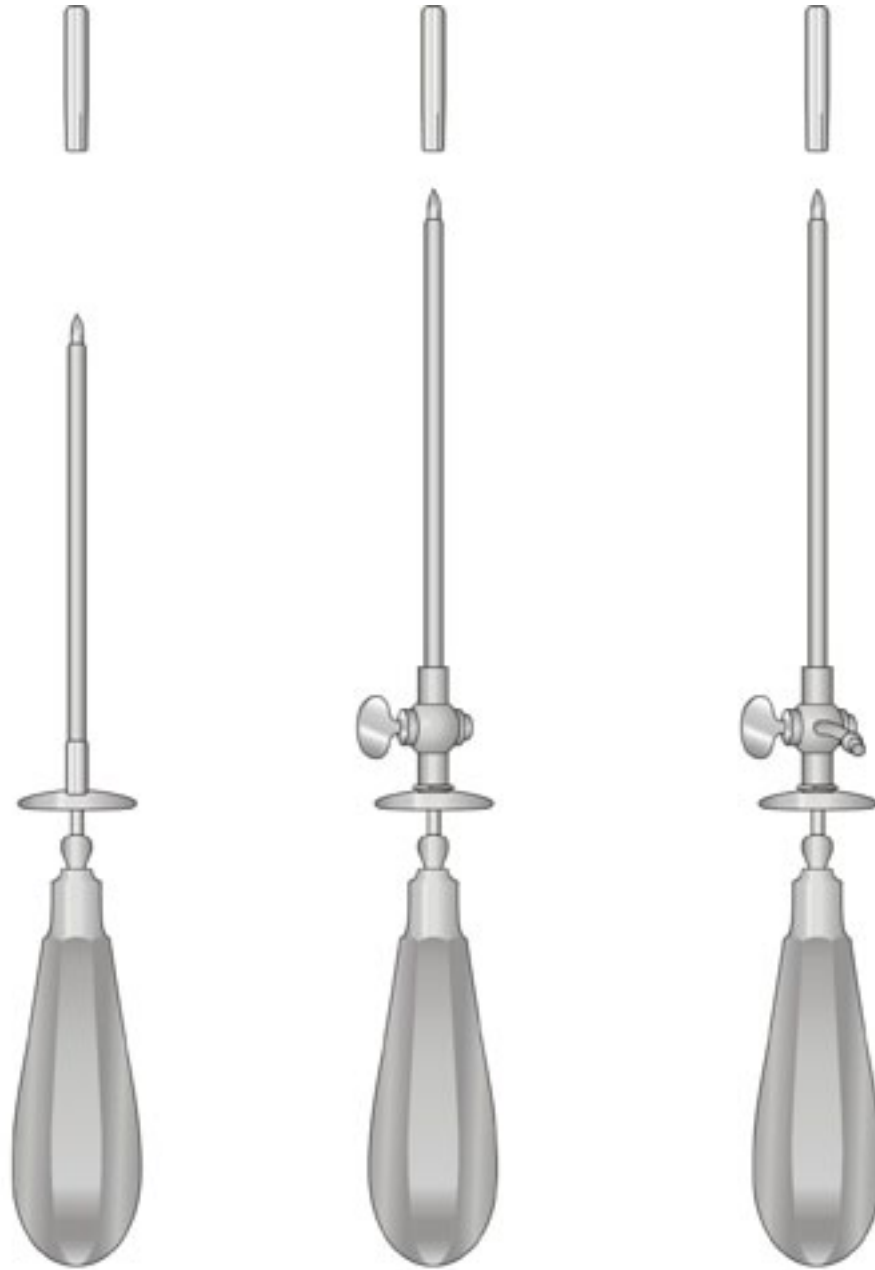

Fig. 1 2 3 4



mm			
außen	innen		
outside	inside		
7,5	6,0	Fig.1	AS.120.07
9,5	8,0	Fig.2	AS.120.09
11,0	9,5	Fig.3	AS.120.11
			AS.120.12
210 mm			

AS



Ø mm Outside
Esterno Außen

3,0	2,0	AS.106.02	AS.107.02	AS.108.02
3,5	2,5	AS.106.03	AS.107.03	AS.108.03
4,0	3,0	AS.106.04	AS.107.04	AS.108.04
4,5	3,5	AS.106.05	AS.107.05	AS.108.05
5,0	4,0	AS.106.06	AS.107.06	AS.108.06
5,0	4,0	AS.106.07	AS.107.07	AS.108.07
5,5	4,5	AS.106.08	AS.107.08	AS.108.08

110 mm

120 mm

120 mm

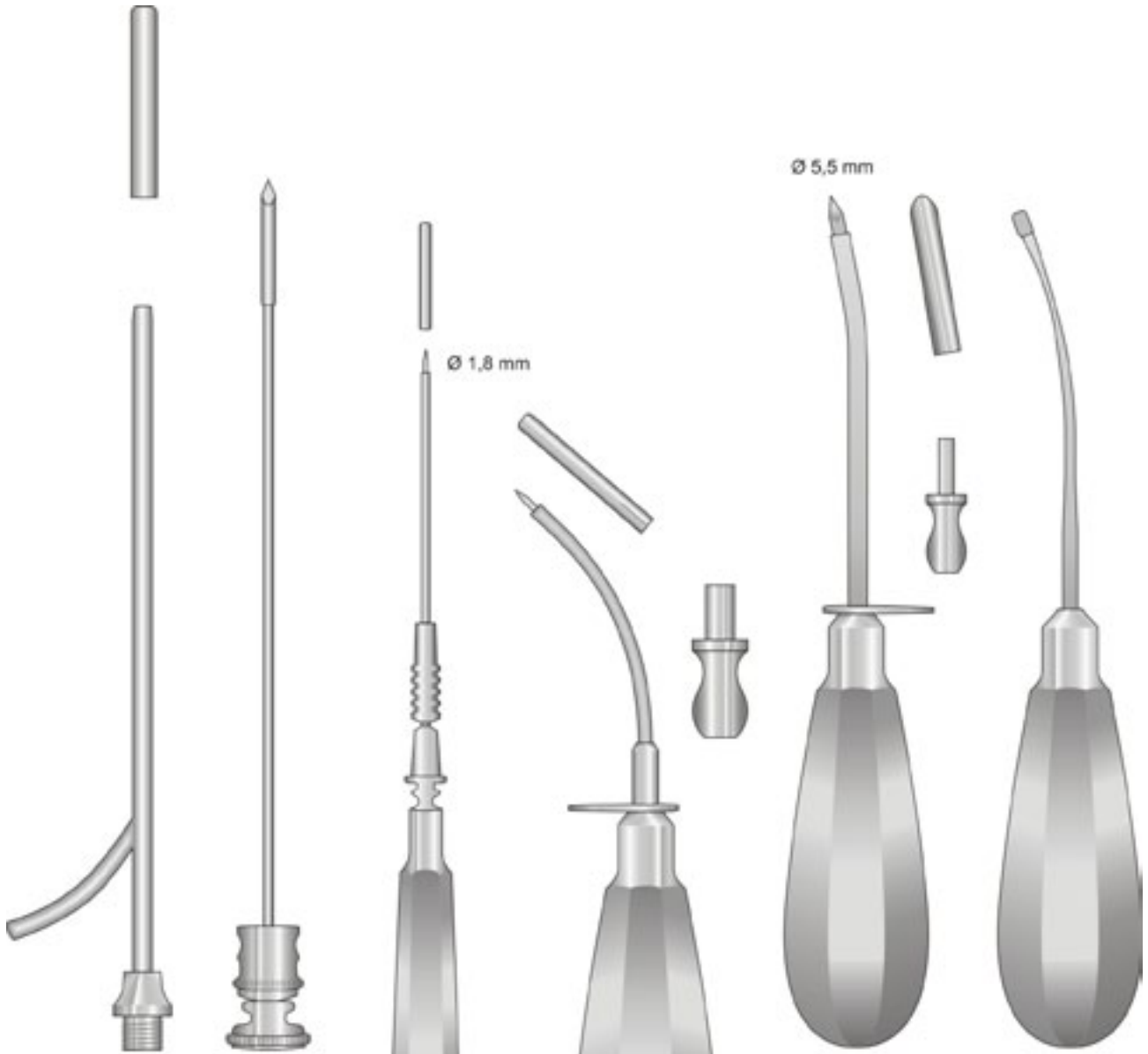

Ochsner

Charr.

- 10 AS.140.10
- 12 AS.140.12
- 14 AS.140.14
- 16 AS.140.16
- 18 AS.140.18
- 20 AS.140.20

Lichtwitz
19cm
AS.150.19

Pierce
16cm
AS.154.03 =3mm
AS.154.04 =4mm
AS.154.05 =5mm

Krause

AS.156.00

SAUGROHRE
SUCTION TUBES

TUBOS ASPIRADORES
TUBES D'ASPIRATION
TUBI ASPIRAZIONE

AS

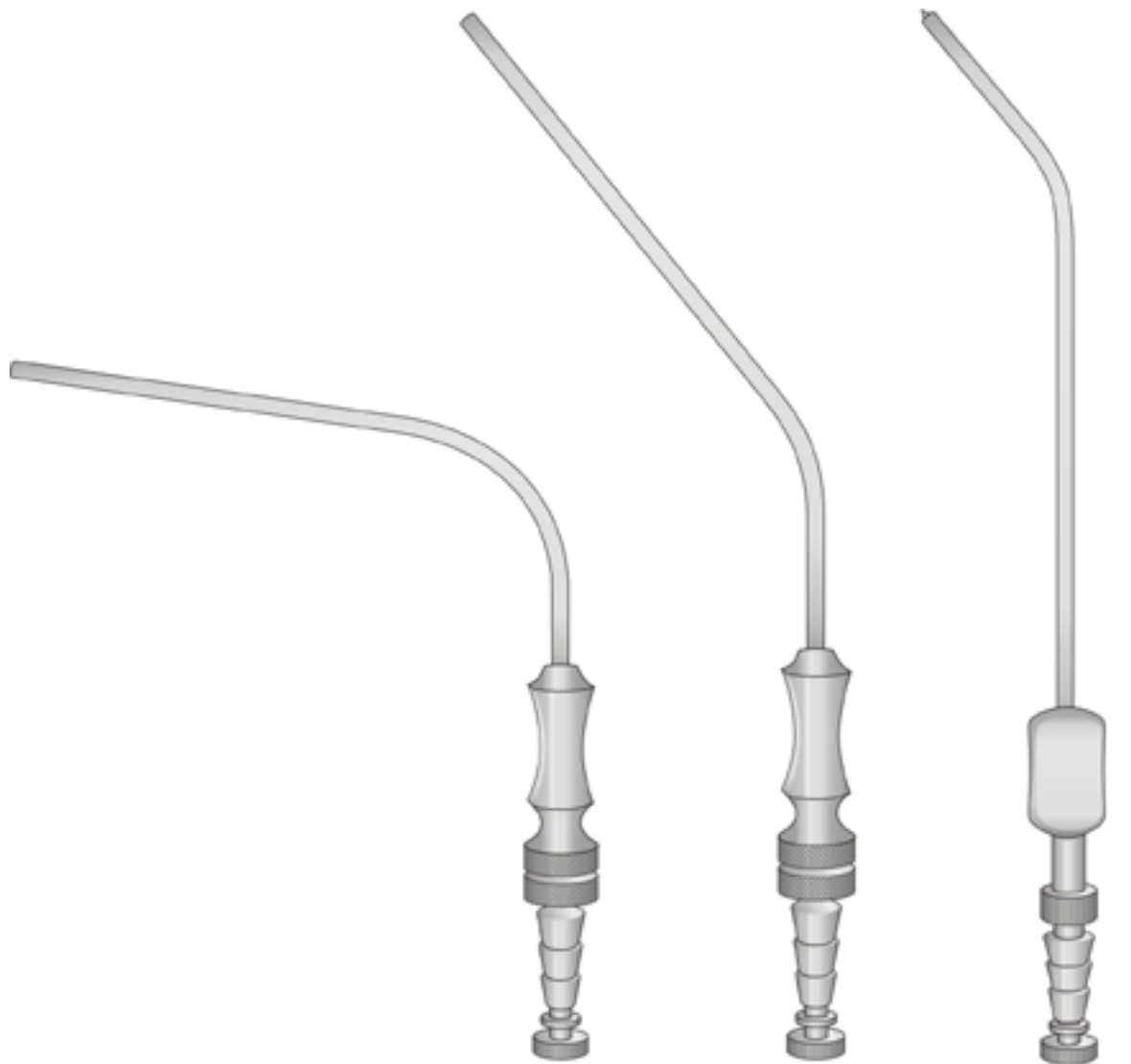

Frazier
18cm

Frazier
18cm

Plester
20cm

Charr.

06	AS.201.06	AS.202.06	AS.203.06
08	AS.201.08	AS.202.08	AS.203.08
10	AS.201.10	AS.202.10	AS.203.10
12	AS.201.12	AS.202.12	AS.203.12



Yankauer
27cm
AS.250.27



SAUGROHRE
SUCTION TUBES

TUBOS ASPIRADORES
TUBES D'ASPIRATION
TUBI ASPIRAZIONE

AS





Coupland
AS.300.00

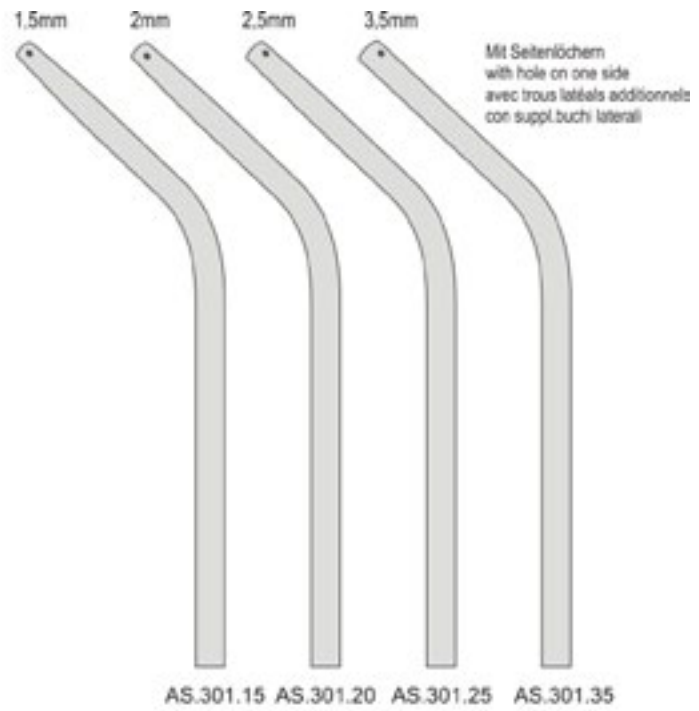

HALTEZANGEN FÜR REDONNADELN
GUIDE NEEDLES FORCEPS

REDON AGUJAS CLAMP
PINCES À AIGULLES
PINZE PER AGHI

AS



17cm
AS.409.17

REDON AGUJAS DE GUIA
 REDON AIGILLES D'INTRODUCTION
 REDON AGHI PER INTRODUZIONE

REDON FÜHRUNGSNADELN
REDON GUIDE NEEDLE

AS



Stufenansatz
Step Formation

Messerspitze gerade
Knife point straight

Article No.	Charr.
AS.410.06	6
AS.410.08	8
AS.410.10	10
AS.410.12	12
AS.410.14	14
AS.410.16	16
AS.410.18	18



Gewindeansatz
Pitch of a Screw

Messerspitze gerade
Knife point straight

Article No.	Charr.
AS.412.06	6
AS.412.08	8
AS.412.10	10
AS.412.12	12
AS.412.14	14
AS.412.16	16
AS.412.18	18



REDON FÜHRUNGSNADELN

REDON GUIDE NEEDLE

REDON AGUJAS DE GUIA
REDON AIGILLES D'INTRODUCTION
REDON AGHI PER INTRODUZIONE

AS



Stufenansatz
Step Formation

Messerspitze gebogen

Knife point curved

Article No.	Charr.
AS.416.08	8
AS.416.10	10
AS.416.12	12
AS.416.14	14
AS.416.16	16
AS.416.18	18



Gewindeansatz
Pitch of a Screw

Messerspitze gebogen

Knife point curved

Article No.	Charr.
AS.418.08	8
AS.418.10	10
AS.418.12	12
AS.418.14	14
AS.418.16	16
AS.418.18	18



REDON AGUJAS DE GUIA
REDON AIGILLES D'INTRODUCTION
REDON AGHI PER INTRODUZIONE

REDON FÜHRUNGSNADELN REDON GUIDE NEEDLE

AS



Stufenansatz
Step Formation

Lanzettspitze gerade
Lancet point straight

Article No.	Charr.
AS.420.06	6
AS.420.08	8
AS.420.10	10
AS.420.12	12
AS.420.14	14
AS.420.16	16
AS.420.18	18



Gewindeansatz
Pitch of a Screw

Lanzettspitze gerade
Lancet point straight

Article No.	Charr.
AS.422.06	6
AS.422.08	8
AS.422.10	10
AS.422.12	12
AS.422.14	14
AS.422.16	16
AS.422.18	18



REDON FÜHRUNGSNADELN

REDON GUIDE NEEDLE

REDON AGUJAS DE GUIA
REDON AIGILLES D'INTRODUCTION
REDON AGHI PER INTRODUZIONE

AS



Stufenansatz
Step Formation

Lanzettspitze gebogen
Lancet point curved

Article No.	Charr.
AS.426.08	8
AS.426.10	10
AS.426.12	12
AS.426.14	14
AS.426.16	16
AS.426.18	18



Gewindeansatz
Pitch of a Screw

Lanzettspitze gebogen
Lancet point curved

Article No.	Charr.
AS.428.08	8
AS.428.10	10
AS.428.12	12
AS.428.14	14
AS.428.16	16
AS.428.18	18



REDON AGUJAS DE GUIA
REDON AIGILLES D'INTRODUCTION
REDON AGHI PER INTRODUZIONE

REDON FÜHRUNGSNADELN REDON GUIDE NEEDLE

AS



Stufenansatz
Step Formation

Trokarspitze gerade
Trocar point straight

Article No.	Charr.
AS.430.06	6
AS.430.08	8
AS.430.10	10
AS.430.12	12
AS.430.14	14
AS.430.16	16
AS.430.18	18



Gewindeansatz
Pitch of a Screw

Trokarspitze gerade
Trocar point straight

Article No.	Charr.
AS.432.06	6
AS.432.08	8
AS.432.10	10
AS.432.12	12
AS.432.14	14
AS.432.16	16
AS.432.18	18



REDON FÜHRUNGSNADELN

REDON GUIDE NEEDLE

REDON AGUJAS DE GUIA
REDON AIGILLES D'INTRODUCTION
REDON AGHI PER INTRODUZIONE

AS

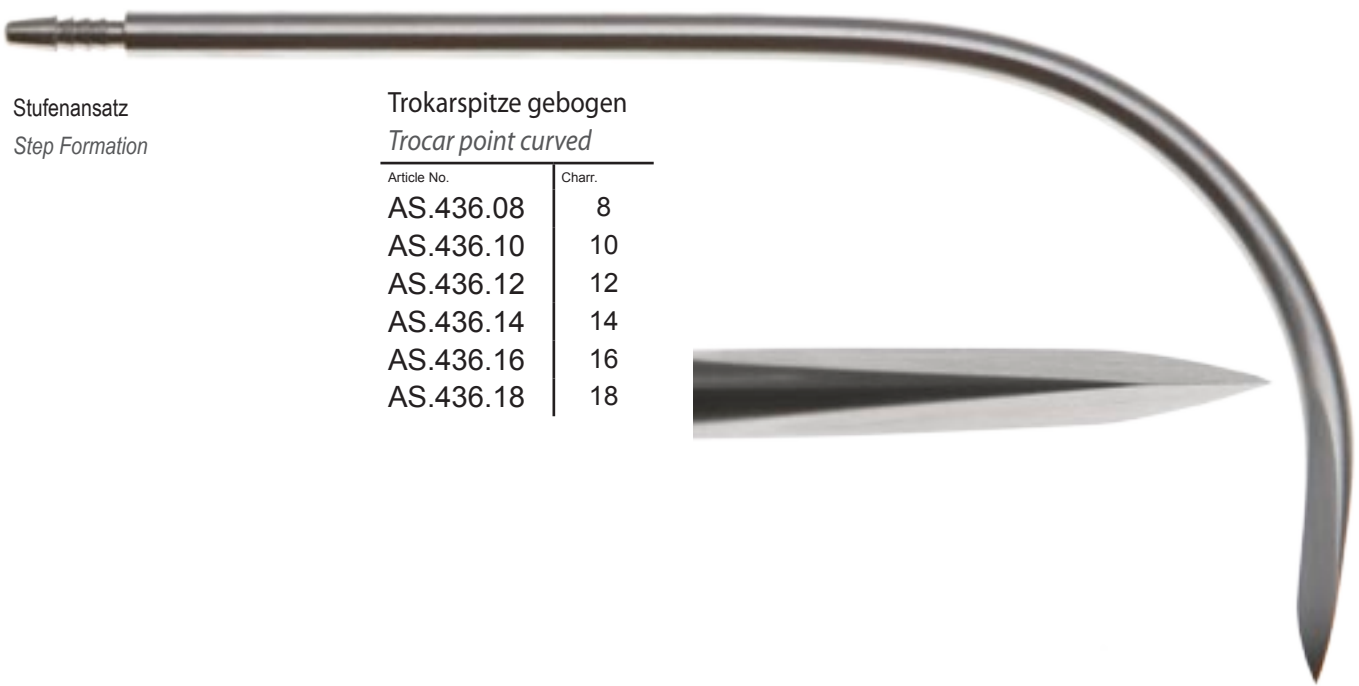

Stufenansatz
Step Formation

Trokarspitze gebogen
Trocar point curved

Article No.	Charr.
AS.436.08	8
AS.436.10	10
AS.436.12	12
AS.436.14	14
AS.436.16	16
AS.436.18	18

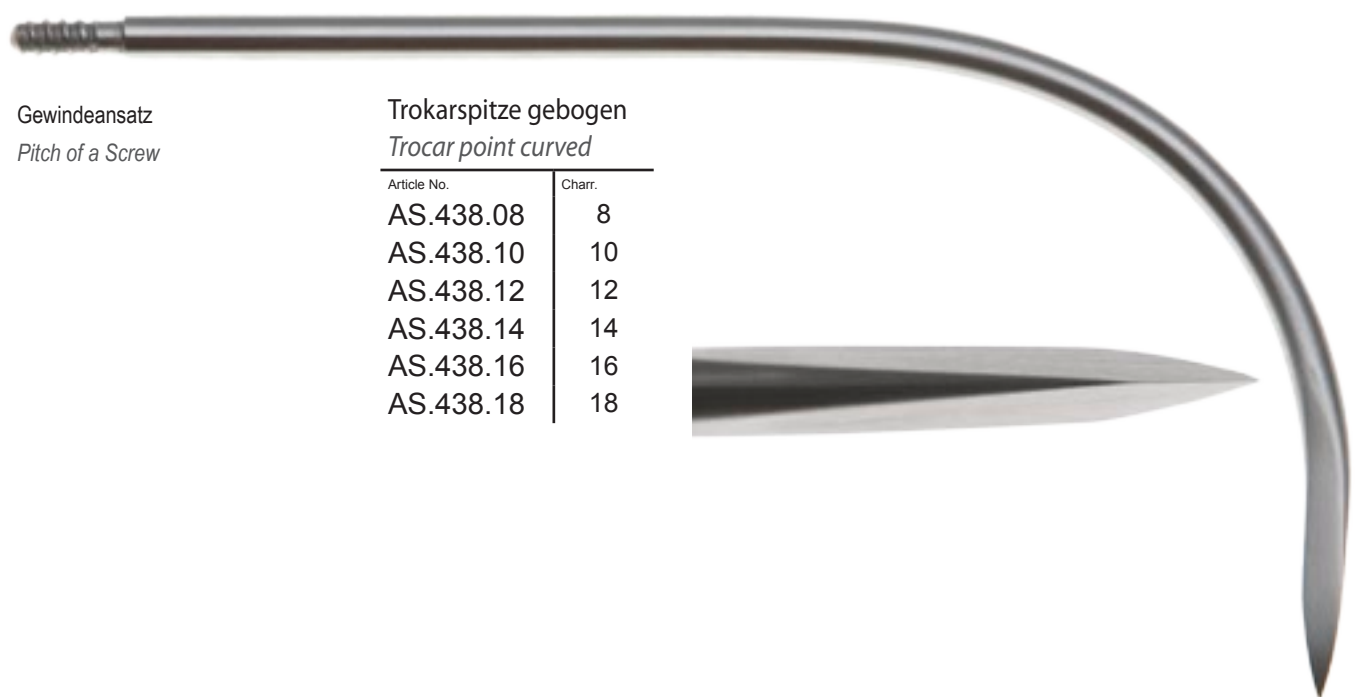

Gewindeansatz
Pitch of a Screw

Trokarspitze gebogen
Trocar point curved

Article No.	Charr.
AS.438.08	8
AS.438.10	10
AS.438.12	12
AS.438.14	14
AS.438.16	16
AS.438.18	18



AS



Klima-Rosegger
AS.524.18



Tuohy
AS.526.41
 =1.20x76mm
AS.526.42
 =1.40x76mm
AS.526.43
 =1.60x76mm



Quincke
AS.526.77
 =0.70x76mm
AS.526.78
 =0.70x89mm
AS.526.80
 =1.00x76mm
AS.526.81
 =1.00x89mm
AS.526.82
 =1.20x76mm
AS.526.83
 =1.20x89mm



Verres
AS.530.08
 =2,1 x 80mm
AS.530.10
 =2,1 x 100mm
AS.530.12
 =2,1 x 120mm
AS.530.15
 2,1 x 150mm
AS.530.17
 2,1 x 170mm

SAUGROHRE
SUCTION TUBES

TUBOS ASPIRADORES
TUBES D'ASPIRATION
TUBI ASPIRAZIONE

AS



Schmid

AS.550.03 AS.550.04 AS.550.05 AS.550.06



AS.560.05 = 1.00x70mm
AS.560.09 = 1.20x70mm
AS.560.12 = 1.20x100mm
AS.560.14 = 1.40x70mm
AS.560.18 = 1.40x100mm

AS.560.22 = 1.50x120mm
AS.560.24 = 1.60x70mm
AS.560.28 = 1.60x100mm
AS.560.29 = 1.80x80mm
AS.560.30 = 1.80x100mm

AS.562.14 = 1.40x168mm
AS.562.18 = 1.80x168mm



Bier

AS.526.10 = 1.00x80mm
AS.526.12 = 1.20x80mm

Menghini



Wullstein Sauggriff
allein
AS.568.90



Franklin-Silvermann

Spaltnadel ohne Wiederhaken

Spaltnadel mit Wiederhaken



AS.570.06



AS.570.08

2.5x145mm

AT

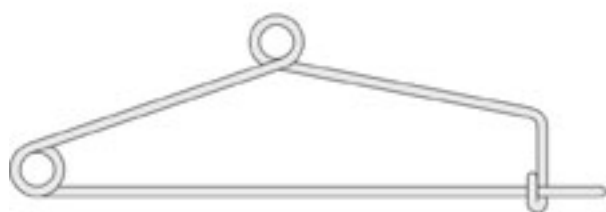

12cm
AT.096.12



Mayo 14cm
AT.096.14



14cm
AT.096.44



14cm
AT.075.14



ROGGE 23cm
AT.086.23



Sauerbruch 55cm
AP.900.55



Cheatle 27cm
AT.080.27



20cm
AT.087.20

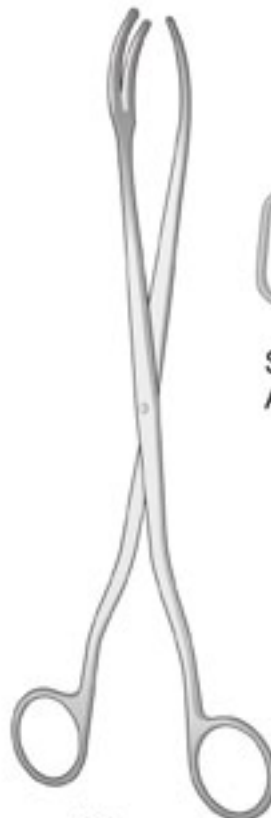

30cm
AT.087.30

BC



Entenschnabel
duck bill

Cusco
BC.110.00 75x15mm
BC.110.01 75x32mm
BC.110.02 85x35mm
BC.110.03 100x35mm



Schweizer Modell
Swiss Pattern
Modelo suizo
Modèle Suisse
Especoli vaginali

Cusco
BC.112.01 90x23-25mm
BC.112.02 100x25-27mm
BC.112.03 110x27-30mm



Mittelantrieb
Central Screw
Vis centrale
Tornillo central
Vite centrale

Cusco
BC.114.00 75x15mm
BC.114.01 80x24mm
BC.114.02 85x36mm
BC.114.03 95x37mm

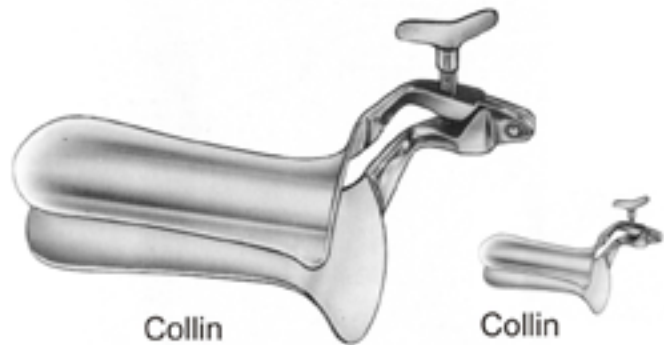

Collin

BC.124.01 85x30mm
BC.124.02 100x35mm
BC.124.03 110x40mm

Collin

BC.122.01 55x10mm
BC.122.02 65x20mm



Pederson

BC.132.01 75x13mm
BC.132.02 100x22mm
BC.132.03 120x25mm



Grave

BC.134.01 75x20mm
BC.134.02 95x35mm
BC.134.03 115x35mm



Semm
BC.138.01 90x14/18mm
BC.138.02 100x17/20mm
BC.138.03 100x25/30mm



Seyffert
BC.140.01 100x17mm
BC.140.02 110x33mm



Collin
BC.122.01 55x10mm
BC.122.02 65x10mm



Sims
BC.150.01 Fig.1
BC.150.02 Fig.2
BC.150.03 Fig.3
BC.150.00 Satz/set of 3



Kallmorgan
BC.158.02
Kallmorgan
BC.158.01

BC.158.00 Satz/set of 2

SCHEIDENSPEKULAS
VAGINAL SPECULA

ESPÉCULOS VAGINALES
SPÉCULUM ET VALVES VAGINAUX
SPECOLI E VALVE VAGINALI

BC

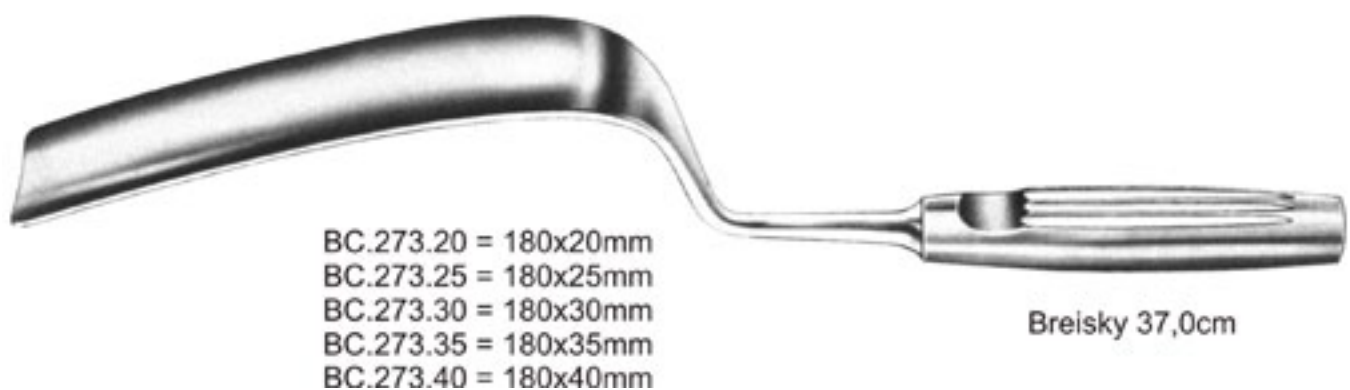
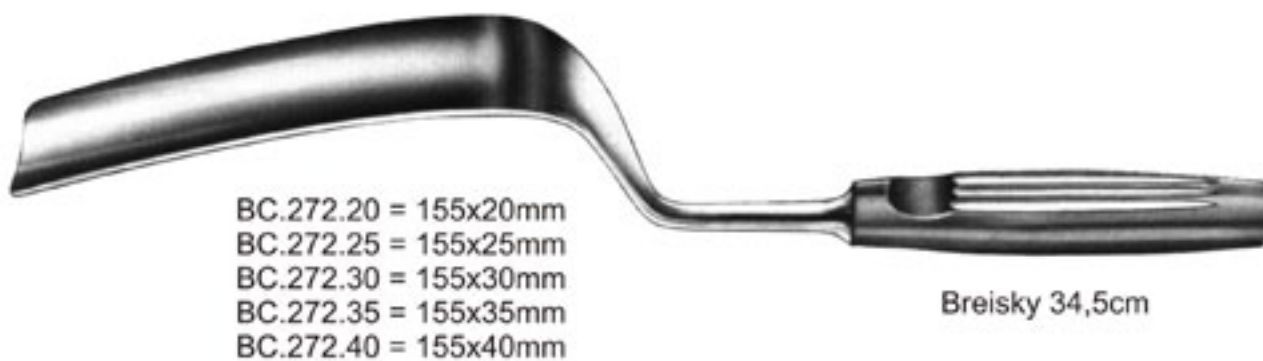
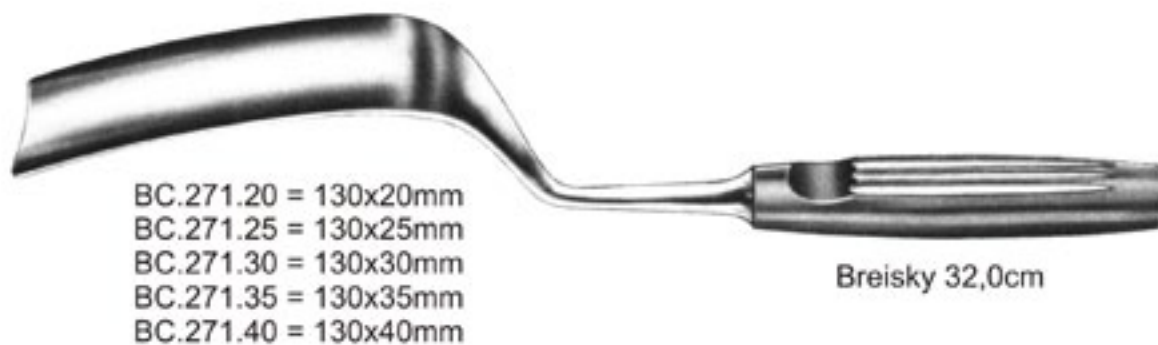



1,0mm	BC.310.01	10,0mm	BC.310.10	19,0mm	BC.310.19
1,5mm	BC.311.01	10,5mm	BC.311.10	19,5mm	BC.311.19
2,0mm	BC.310.02	11,0mm	BC.310.11	20,0mm	BC.310.20
2,5mm	BC.311.02	11,5mm	BC.311.11	21,0mm	BC.310.21
3,0mm	BC.310.03	12,0mm	BC.310.12	22,0mm	BC.310.22
3,5mm	BC.311.03	12,5mm	BC.311.12	23,0mm	BC.310.23
4,0mm	BC.310.04	13,0mm	BC.310.13	24,0mm	BC.310.24
4,5mm	BC.311.04	13,5mm	BC.311.13	25,0mm	BC.310.25
5,0mm	BC.310.05	14,0mm	BC.310.14	26,0mm	BC.310.26
5,5mm	BC.311.05	14,5mm	BC.311.14		
6,0mm	BC.310.06	15,0mm	BC.310.15		
6,5mm	BC.311.06	15,5mm	BC.311.15		
7,0mm	BC.310.07	16,0mm	BC.310.16		
7,5mm	BC.311.07	16,5mm	BC.311.16		
8,0mm	BC.310.08	17,0mm	BC.310.17		
8,5mm	BC.311.08	17,5mm	BC.311.17		
9,0mm	BC.310.09	18,0mm	BC.310.18		
9,5mm	BC.311.09	18,5mm	BC.311.18		

Hegar
einendig/single end



1+2mm	BC.315.02
3+4mm	BC.315.04
5+6mm	BC.315.06
7+8mm	BC.315.08
9+10mm	BC.315.10
11+12mm	BC.315.12
13+14mm	BC.315.14
15+16mm	BC.315.16
17+18mm	BC.315.18
19+20mm	BC.315.20
21+22mm	BC.315.22
23+24mm	BC.315.24
25+26mm	BC.315.26

Hegar
doppelendig



Satz mit 14 Dilatatoren 4-17mm
 Set of 14 diladators 4-17mm
 BC.310.80

Satz mit 26 Dilatatoren 1-26mm
 Set of 26 diladators 1-26mm
 BC.310.90

PROBEEEXZISIONSZANGEN
CERVICAL BIOPSY AND SPECIMEN FORCEPS

PINZAS SACA-BOCADOS PARA BIOPSIA
 PINCES EMPORTE-PIÈCES À BIOPSIE
 PINZE TAGLIANTI PER BIOPSIA

BC



Faure
 21cm
 BC.503.21



Schubert
 21cm
 BC.506.21

29cm
 BC.506.29

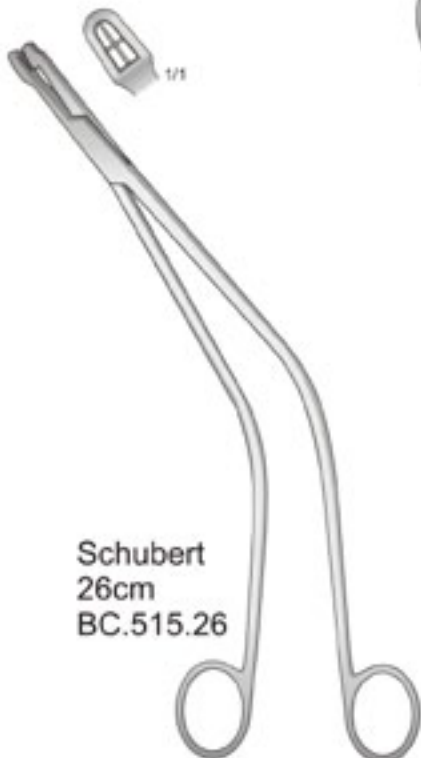

Schubert
 26cm
 BC.515.26



Van Doren
 24cm
 BC.521.25

PROBEEZSIONSZANGEN CERVICAL BIOPSY AND SPECIMEN FORCEPS

BC

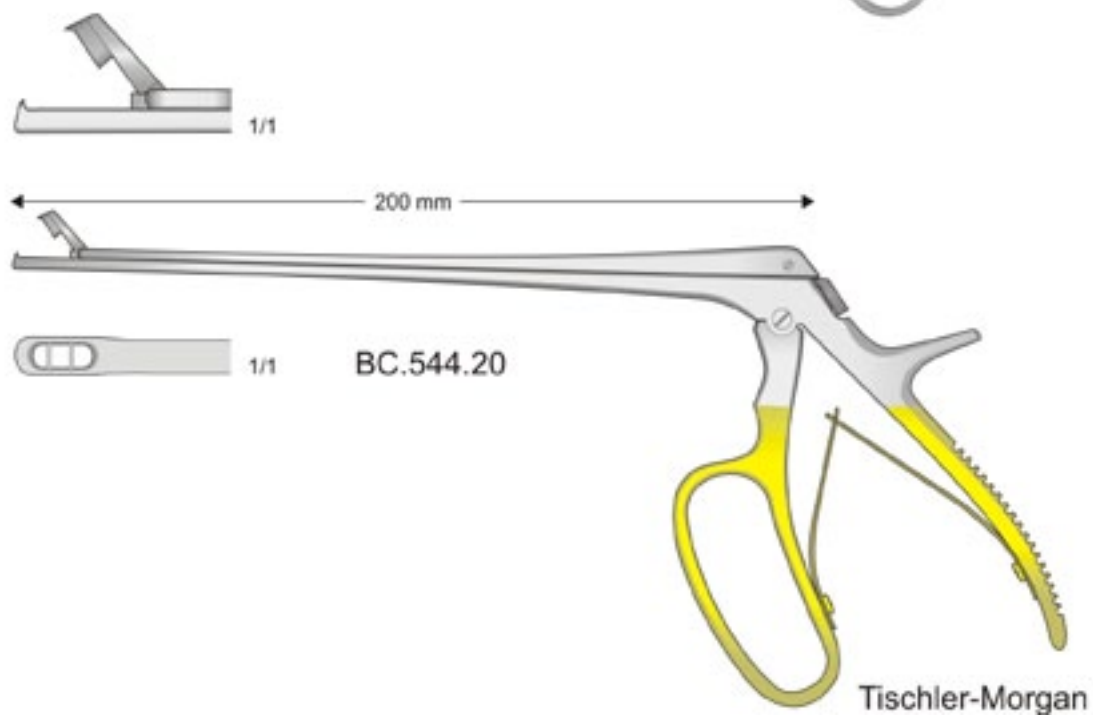
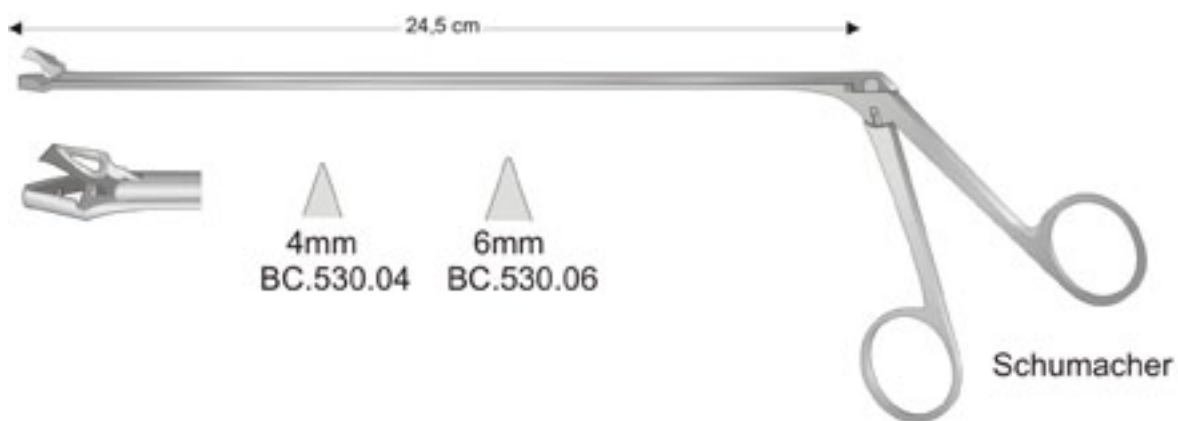

UTERUS LÖFFEL
UTERINE SCOOPS

CURETAS UTERINAS
CURETTES UTÉRINES
CURETTE UTERINE

BC



Simon
24cm



Fig.1
BC.830.01



Fig.2
BC.830.02



Fig.3
BC.830.03



Fig.4
BC.830.04



Fig.5
BC.830.05



Fig.6
BC.830.06



Schröder
31cm



Fig.1
BC.832.01



Fig.2
BC.832.02



Fig.3
BC.832.03



Fig.4
BC.832.04



Fig.5
BC.832.05



Fig.6
BC.832.06



Caspar mit Langloch

Gerade
 Straight
 Recta
 Droit

Maulgröße

Size of jaw
 Anchura de la boca
 Largeur des mors

Schaftlänge

Length of shaft
 Longitud del vastago
 Longueur de la tige



	140 mm	160 mm	185 mm
2 x 12 mm	CF.274.02	CF.274.12	CF.274.22
3 x 12 mm	CF.274.03	CF.274.13	CF.274.23
4 x 14 mm	CF.274.04	CF.274.14	CF.274.24
5 x 14 mm	CF.274.05	CF.274.15	CF.274.25
6 x 16 mm	CF.274.06	CF.274.16	CF.274.26

Aufgebogen

Curved up
 Curva hacia arriba
 Courbure vers le haut

Maulgröße

Size of jaw
 Anchura de la boca
 Largeur des mors

Schaftlänge

Length of shaft
 Longitud del vastago
 Longueur de la tige



30°

	140 mm	160 mm	185 mm
2 x 12 mm	CF.275.02	CF.275.12	CF.275.22
3 x 12 mm	CF.275.03	CF.275.13	CF.275.23
4 x 14 mm	CF.275.04	CF.275.14	CF.275.24
5 x 14 mm	CF.275.05	CF.275.15	CF.275.25
6 x 16 mm	CF.275.06	CF.275.16	CF.275.26

**Abwärts -
 gebogen**

Curved down
 Curva hacia abajo
 Courbure vers le bas

Maulgröße

Size of jaw
 Anchura de la boca
 Largeur des mors

Schaftlänge

Length of shaft
 Longitud del vastago
 Longueur de la tige



30°

	140 mm	160 mm	185 mm
2 x 12 mm	CF.276.02	CF.276.12	CF.276.22
3 x 12 mm	CF.276.03	CF.276.13	CF.276.23
4 x 14 mm	CF.276.04	CF.276.14	CF.276.24
5 x 14 mm	CF.276.05	CF.276.15	CF.276.25
6 x 16 mm	CF.276.06	CF.276.16	CF.276.26

ATRAUMATISCHE GEFÄSSKLEMMEN
ATRAUMATIC VASCULAR CLAMP

PINZAS VASCULARES CON BOCAS ATRAUMATIC
 PINCE-CLAMPS VASCULAIRES ATRAUMATIQUES
 PINZE VASCOLARI ATRAUMATIC

DB



De Bakey - Brainbridge
 15,5cm



De Bakey - Brainbridge
 18cm



Derra 17cm

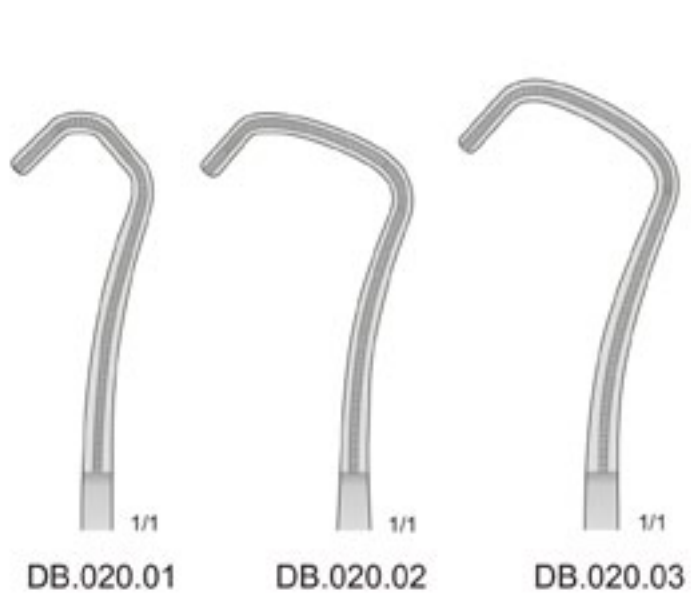

ATRAUMATISCHE GEFÄSSKLEMMEN ATRAUMATIC VASCULAR CLAMP

DB



Leland-Jones



18,5cm
DB.025.18



19cm
DB.027.19



De Bakey 18cm
DB.031.18



ATRAUMATISCHE GEFÄSSKLEMMEN
ATRAUMATIC VASCULAR CLAMP

PINZAS VASCULARES CON BOCAS ATRAUMATIC
PINCE-CLAMPS VASCULAIRES ATRAUMATIQUES
PINZE VASCOLARI ATRAUMATIC

DB



De Bakey 20cm
DB.035.20



De Bakey 22cm
DB.038.22



Cooley

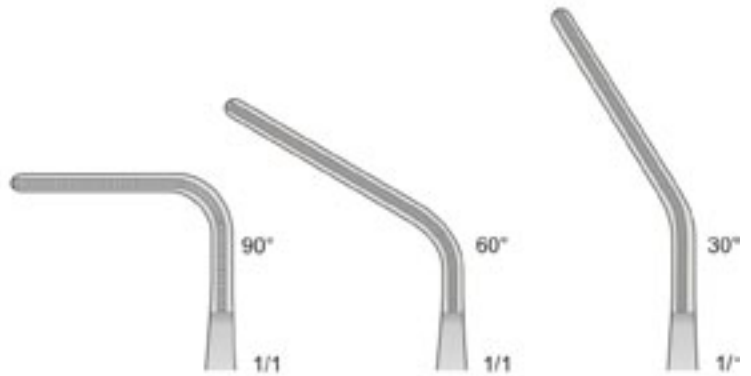

14cm
DB.041.14

15cm
DB.041.15

16cm
DB.041.16

ATRAUMATISCHE GEFÄSSKLEMMEN

ATRAUMATIC VASCULAR CLAMP

DB



Cooley 16cm
DB.045.16

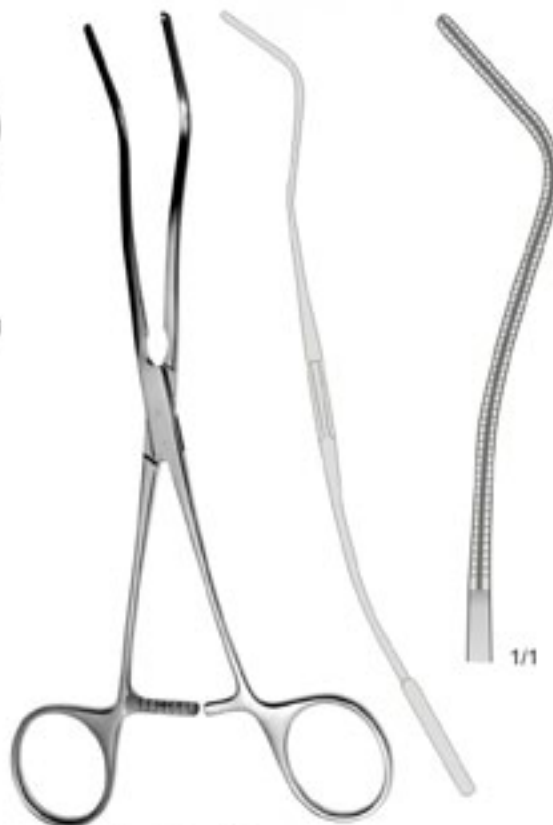

Cooley 20cm
DB.047.20



De Bakey 15cm



DB.051.15



DB.053.15

ATRAUMATISCHE GEFÄSSKLEMMEN
ATRAUMATIC VASCULAR CLAMP

PINZAS VASCULARES CON BOCAS ATRAUMATIC
PINCE-CLAMPS VASCULAIRES ATRAUMATIQUES
PINZE VASCOLARI ATRAUMATIC

DB



De Bakey 19cm
DB.057.19

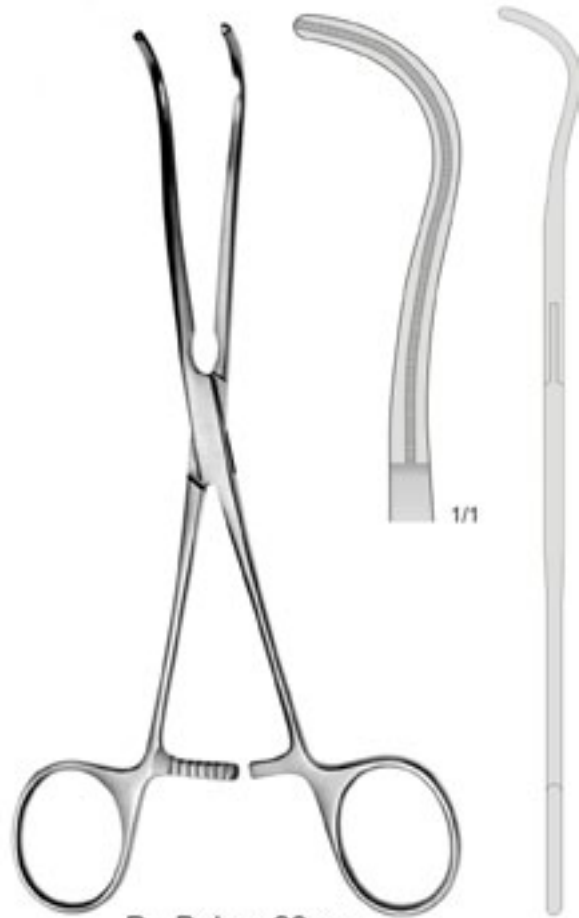

De Bakey 23cm
DB.057.23

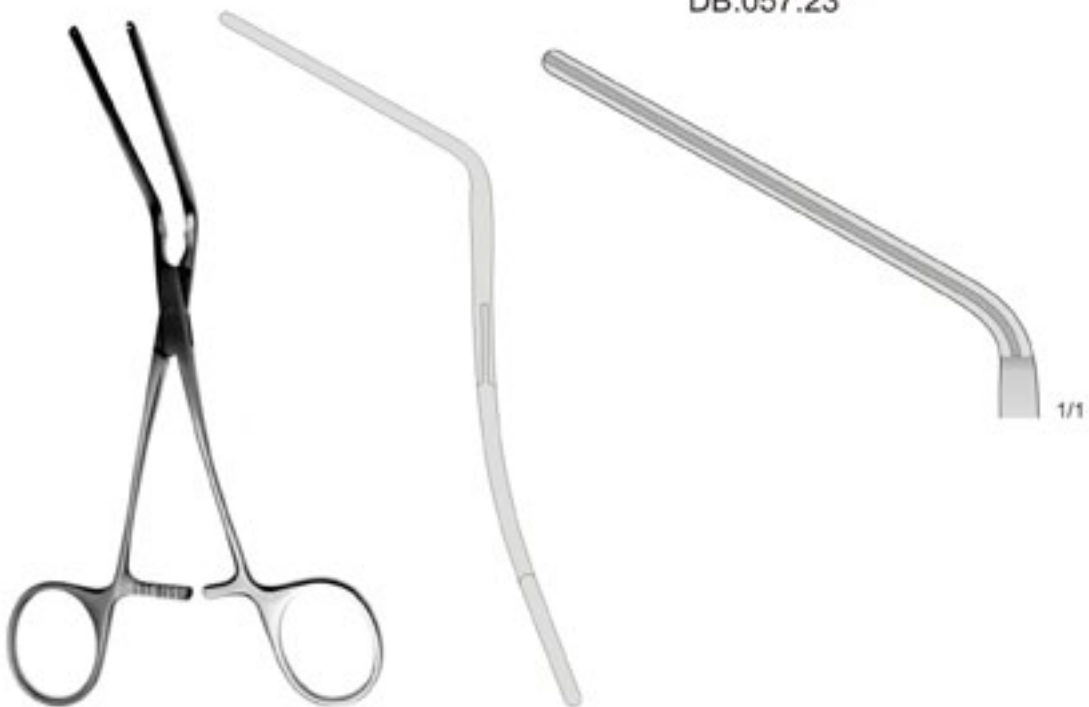

De Bakey 16,5cm
DB.059.16



De Bakey 16,5cm
DB.062.16



De Bakey 16,5cm
DB.063.16



De Bakey 16cm
DB.064.16

ATRAUMATISCHE GEFÄSSKLEMMEN
ATRAUMATIC VASCULAR CLAMP

PINZAS VASCULARES CON BOCAS ATRAUMATIC
PINCE-CLAMPS VASCULAIRES ATRAUMATIQUES
PINZE VASCOLARI ATRAUMATIC

DB

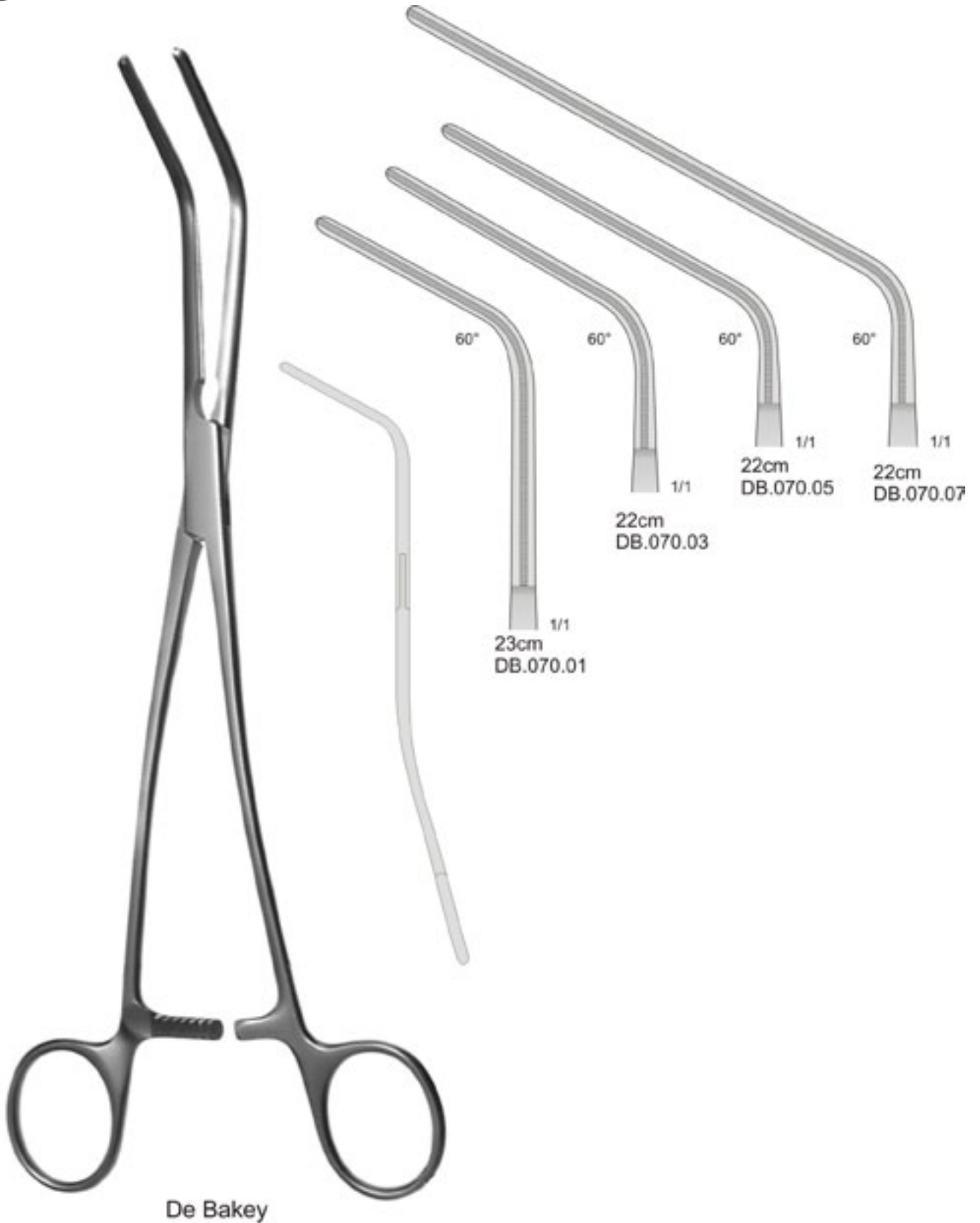

De Bakey

ATRAUMATISCHE GEFÄSSKLEMMEN

ATRAUMATIC VASCULAR CLAMP

DB



De Bakey



ATRAUMATISCHE GEFÄSSKLEMMEN
ATRAUMATIC VASCULAR CLAMP

PINZAS VASCULARES CON BOCAS ATRAUMATIC
 PINCE-CLAMPS VASCULAIRES ATRAUMATIQUES
 PINZE VASCOLARI ATRAUMATIC

DB

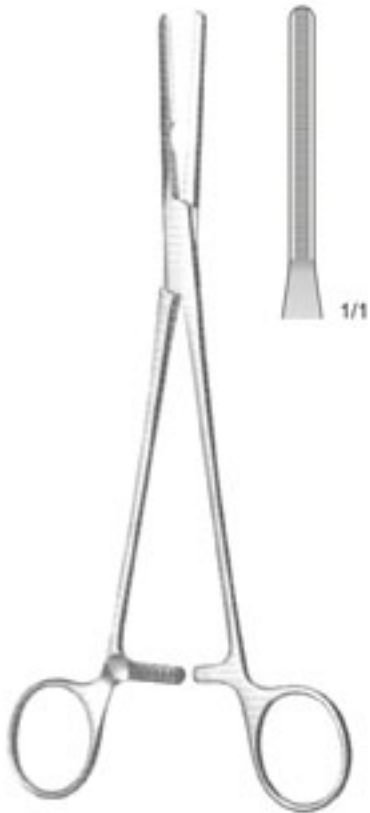

De Bakey 21,5cm
 DB.078.21



De Bakey 21,5cm
 DB.079.21



De Bakey

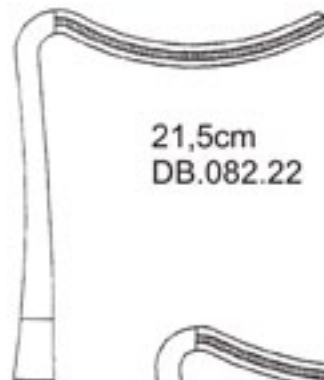

21,5cm
 DB.082.22

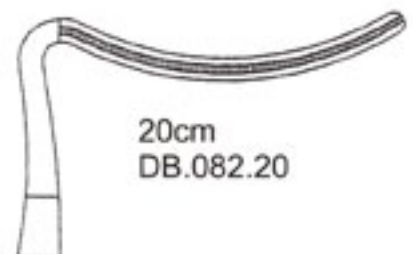

20cm
 DB.082.20

ATRAUMATISCHE GEFÄSSKLEMMEN

ATRAUMATIC VASCULAR CLAMP

DB



De Bakey



25cm
DB.087.25



27cm
DB.087.27



28cm
DB.087.28



Lambert-Kay 22cm
DB.091.22



OHRPINZETTEN

EAR AND NASAL DRESSING FORCEPS

PINZAS AURICULARES Y NASALES
PINCES AURICULAIRES ET NISAU
PINZE PER ORECCHIO A NASALE

FA

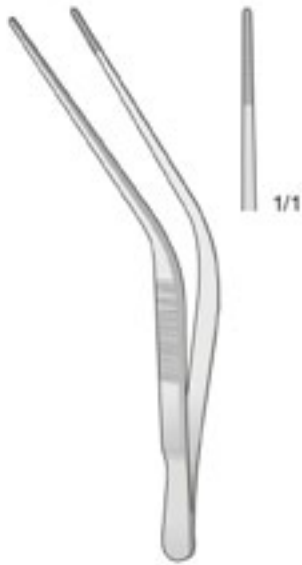

Troeltsch (Wilde) 13cm
FA.301.13

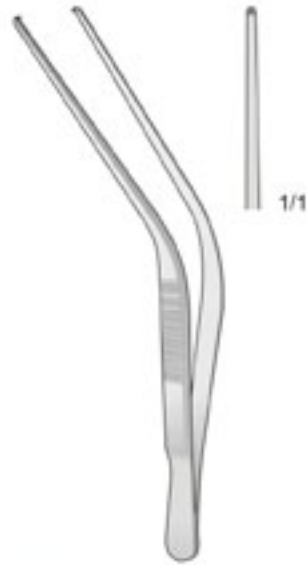

FA.302.13



Troeltsch (Wilde) 13cm
FA.305.13



Lucae 14cm
FA.309.14







Jansen 16cm
FA.309.16



Jansen 16cm
FA.310.16



Jansen 19cm
FA.309.19

-  FA.600.20 = 2mm
-  FA.600.25 = 2,5mm
-  FA.600.30 = 3mm
-  FA.600.35 = 3,5mm
-  FA.600.40 = 4mm

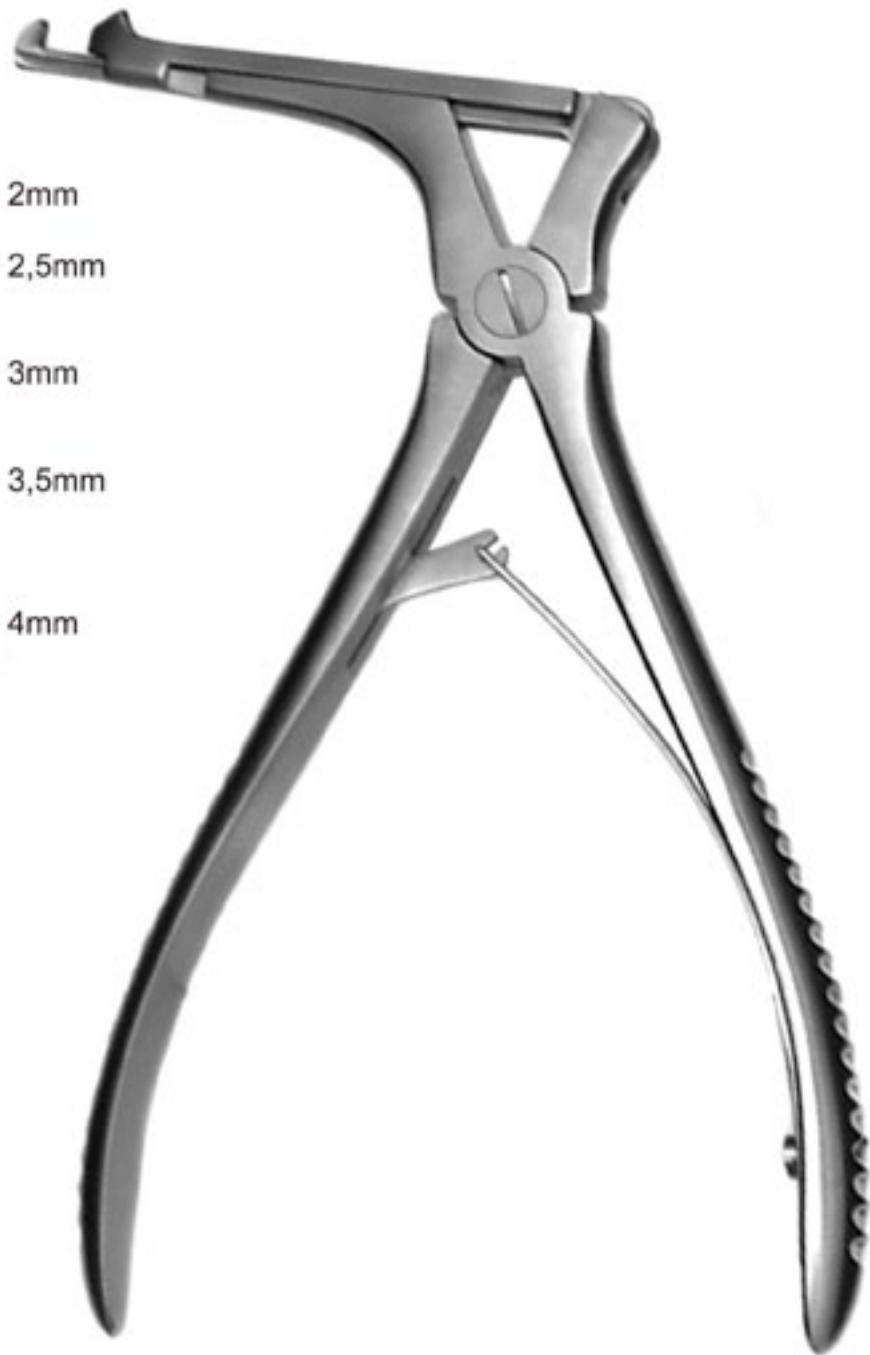

Citelli

FB



Hartmann

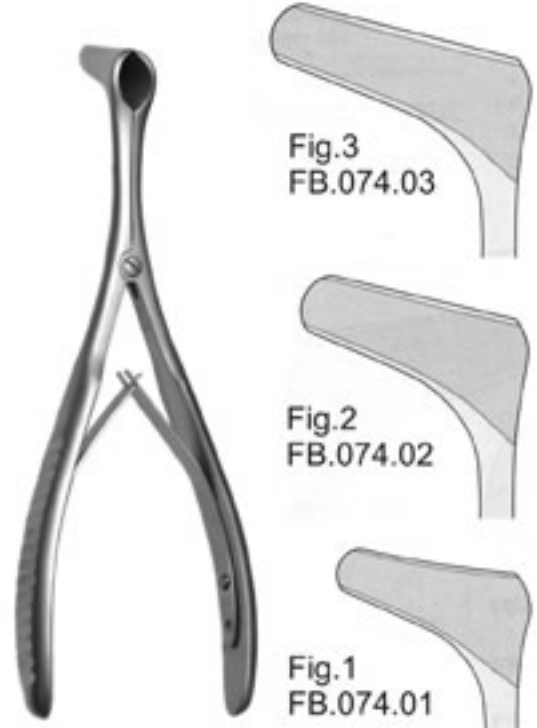

Hartmann-Halle

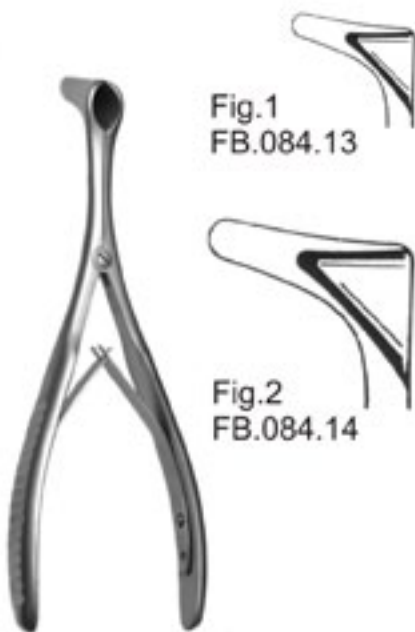

Tieck-Halle

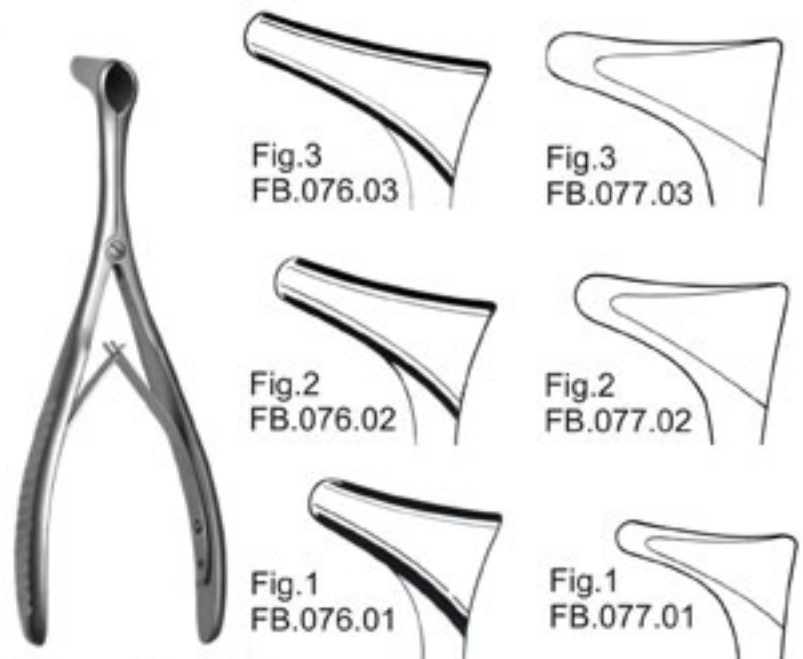

Wiener Modell

FOMON RASPA
FOMON TÁPES
FOMON LIMA PER OS

FOMON RASPELN
FOMON RASPS

FB



TC



1



3



5



7



9



2



4



6



8



10

Fomon HM Raspel

Size
20,0cm

FB.800.12

FB.800.34

FB.800.56

FB.800.78

FB.800.9C

**WUNDHAKEN
RETRACTORS**

SEPARADORES
ECARTEURS
DIVARICATORI

FB



Joseph 16cm

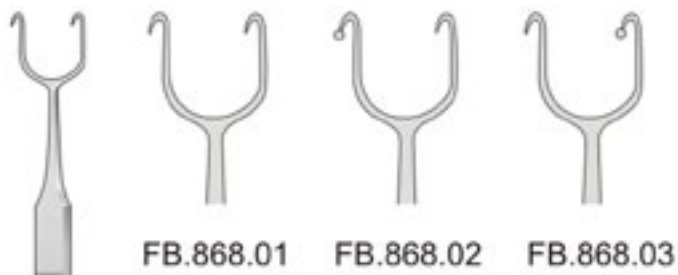

Cottle 15cm



Fomon 16cm
FB.864.16

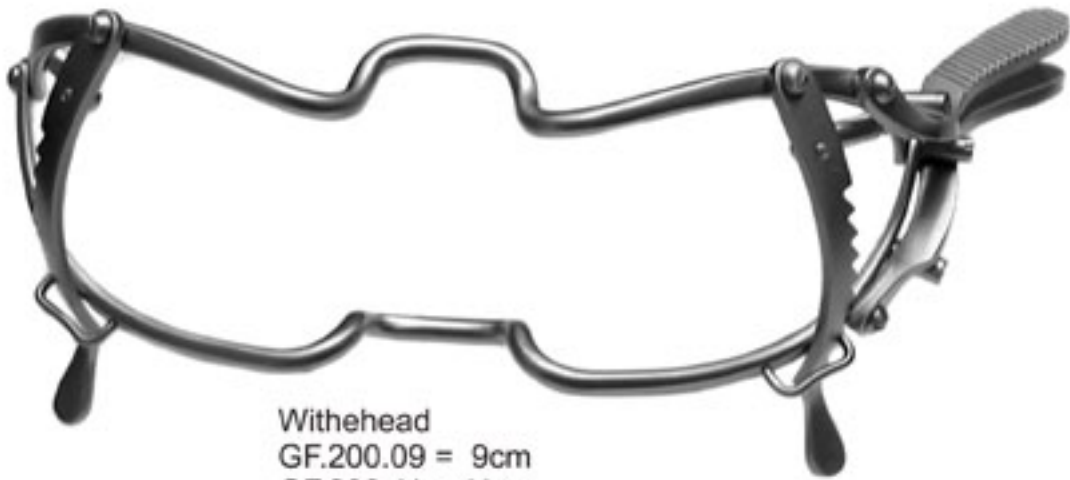

Withehead
GF.200.09 = 9cm
GF.200.11 = 11cm
GF.200.13 = 13cm
GF.200.15 = 15cm

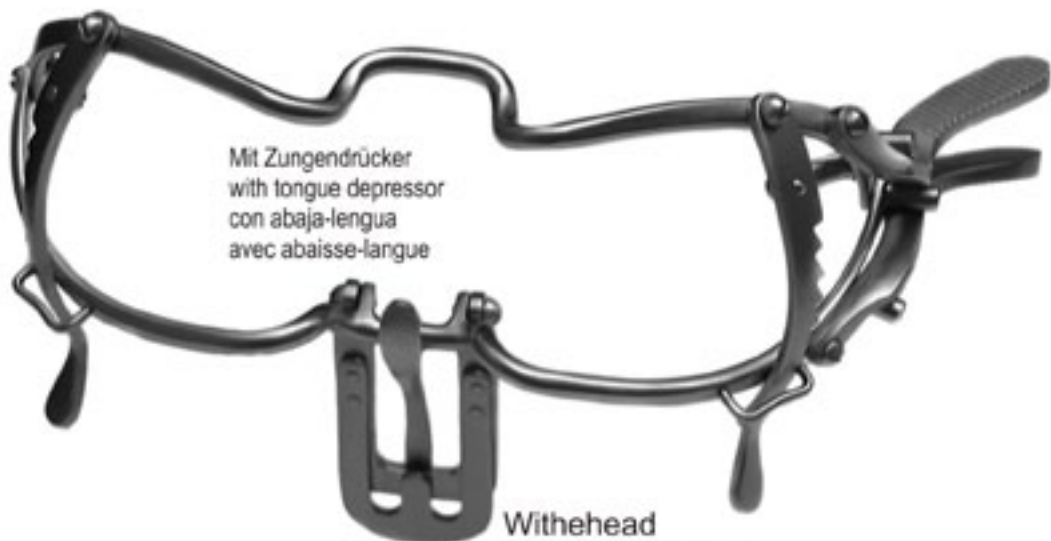

Mit Zungendrucker
with tongue depressor
con abaja-lengua
avec abaisse-langue

Withehead
GF.201.09 = 9cm
GF.201.11 = 11cm
GF.201.13 = 13cm
GF.201.15 = 15cm



Jennings
GF.202.09 = 9cm
GF.202.11 = 11cm
GF.202.13 = 13cm
GF.202.15 = 15cm

ZUNGEN & WANGENHALTER
TONGUE AND LIP RETRACTORS

ECARTEURS DES LÈVRES ET DES JOUES
 RETRACTORES DES LABIOS ET SEPARADORES
 DIVARICATORE PER E LABBRA

GF

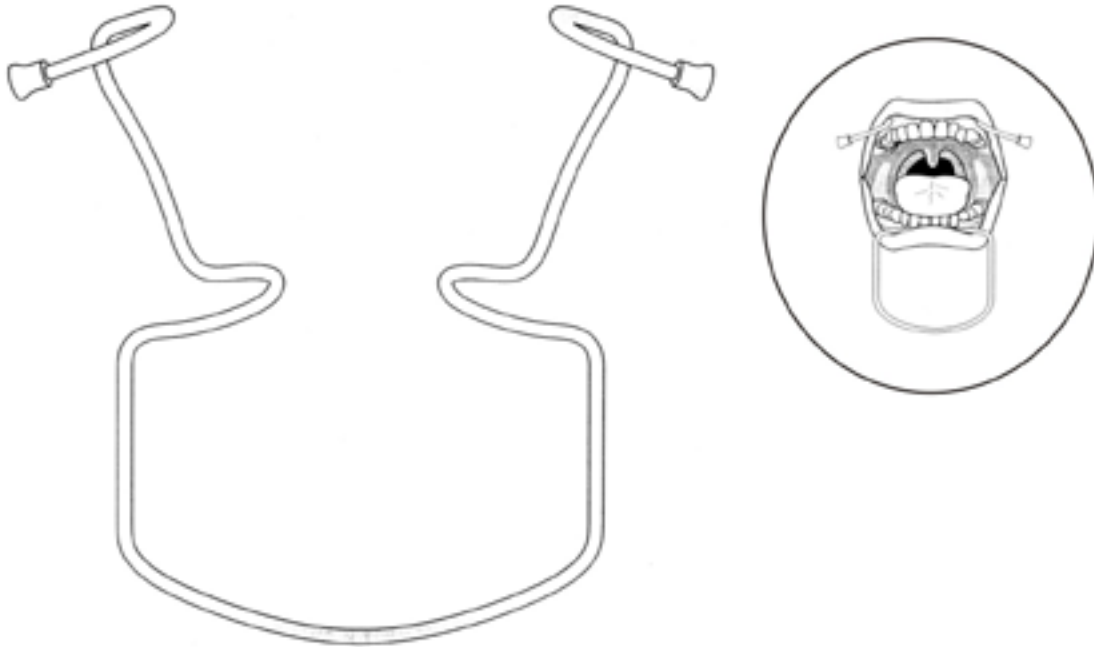

Orringer
 GF.210.00 Satz/Set/Jeu/Serie 0-3
 GF.210.01 Fig. 0 100x 95mm
 GF.210.02 Fig. 1 115x105mm
 GF.210.04 Fig. 2 115x110mm
 GF.210.05 Fig. 3 125x115mm



Sternberg
 GF.212.12 = 12cm
 GF.212.14 = 14cm
 GF.212.16 = 16cm



Columbia 14cm
 GF.215.14

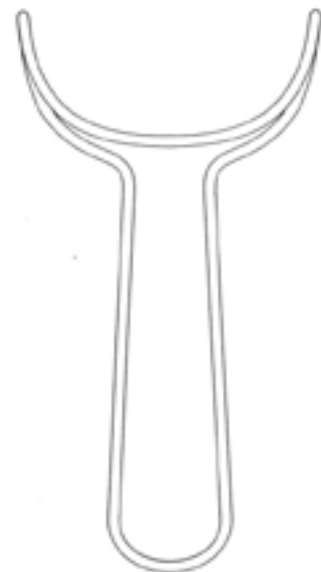

MEDE Special
 GF.216.15

PERIOSTÔTOMES CON MANGOS DE FERROZELL
RUGINES MANCHE EN FERROZELL
PERIOSTOMI MANICO IN FERROZELL

RASPATORIEN MIT FERROZELLGRIFF RASPATORIES WITH FERROZELL-HANDLE

KA



6mm

Raspatorium

Article No.	Size
KA.136.18	18,0cm



6mm

Raspatorium

Article No.	Size
KA.138.18	18,0cm



3mm

Raspatorium

Article No.	Size
KA.140.18	18,0cm

RASPATORIEN MIT FERROZELLGRIFF
RASPATORIES WITH FERROZELL-HANDLE

PERIOSTÓTOMES CON MANGOS DE FERROZELL
 RUGINES MANCHE EN FERROZELL
 PERIOSTOMI MANICO IN FERROZELL

KA



14mm

Raspatorium

Article No.	Size
KA.141.14	20,0cm



14mm

Raspatorium

Article No.	Size
KA.142.14	20,0cm



20mm

Raspatorium

Article No.	Size
KA.142.20	20,0cm

1:1

5mm



7mm



6mm



8mm



Mini Hohmann

Article No.	Size
KA.300.05	14,0cm

Mini Hohmann

Article No.	Size
KA.300.07	14,0cm

Mini Hohmann

Article No.	Size
KA.302.06	16,0cm

Mini Hohmann

Article No.	Size
KA.302.08	16,0cm

KNOCHENHEBEL
BONE LEVERS

ELEVADORES PARA HUESOS
LEVIERSÀ OS
ELEVATORIS PER OSSA

KA

1:1



Knochenheber

Article No.	Size
KA.304.12	12,5cm

Knochenheber

Article No.	Size
KA.304.15	15,0cm

Knochenheber

Article No.	Size
KA.306.15	15,0cm

Knochenheber

Article No.	Size
KA.307.14	14,0cm



KNOCHENHEBEL
BONE LEVERS

ELEVADORES PARA HUESOS
LEVIERSÀ OS
ELEVATORIS PER OSSA

KA



Hohman
KA.320.70
24,0cm

Hohman
KA.321.43
24,5cm

Hohmann
KA.323.22
26,0cm

Hohmann
KA.323.33
28,0cm

1:2

KA



Hohmann
KA.324.24
26,0cm



Lange-Hohmann
KA.325.22
26,0cm



Lange-Hohmann
KA.325.30
26,5cm



Lange-Hohmann
KA.325.33
28,0cm

KNOCHENHEBEL
BONE LEVERS

ELEVADORES PARA HUESOS
LEVIERSÀ OS
ELEVATORIS PER OSSA

KA

1:2



Lange-Hohmann

KA.326.14

14,0cm

18x35mm
Unterseite kariert



Schumacher

KA.326.29

29,0cm

18x37mm



Schumacher

KA.326.34

34,5cm

1:2



Verbrügge
Like Simal

KA.327.25

20,0cm



Verbrügge
Müller

KA.327.44

24,0cm



Verbrügge
Müller

KA.327.65

25,5cm

KNOCHENHEBEL
BONE LEVERS

ELEVADORES PARA HUESOS
LEVIERSÀ OS
ELEVATORIS PER OSSA

KA

1:2

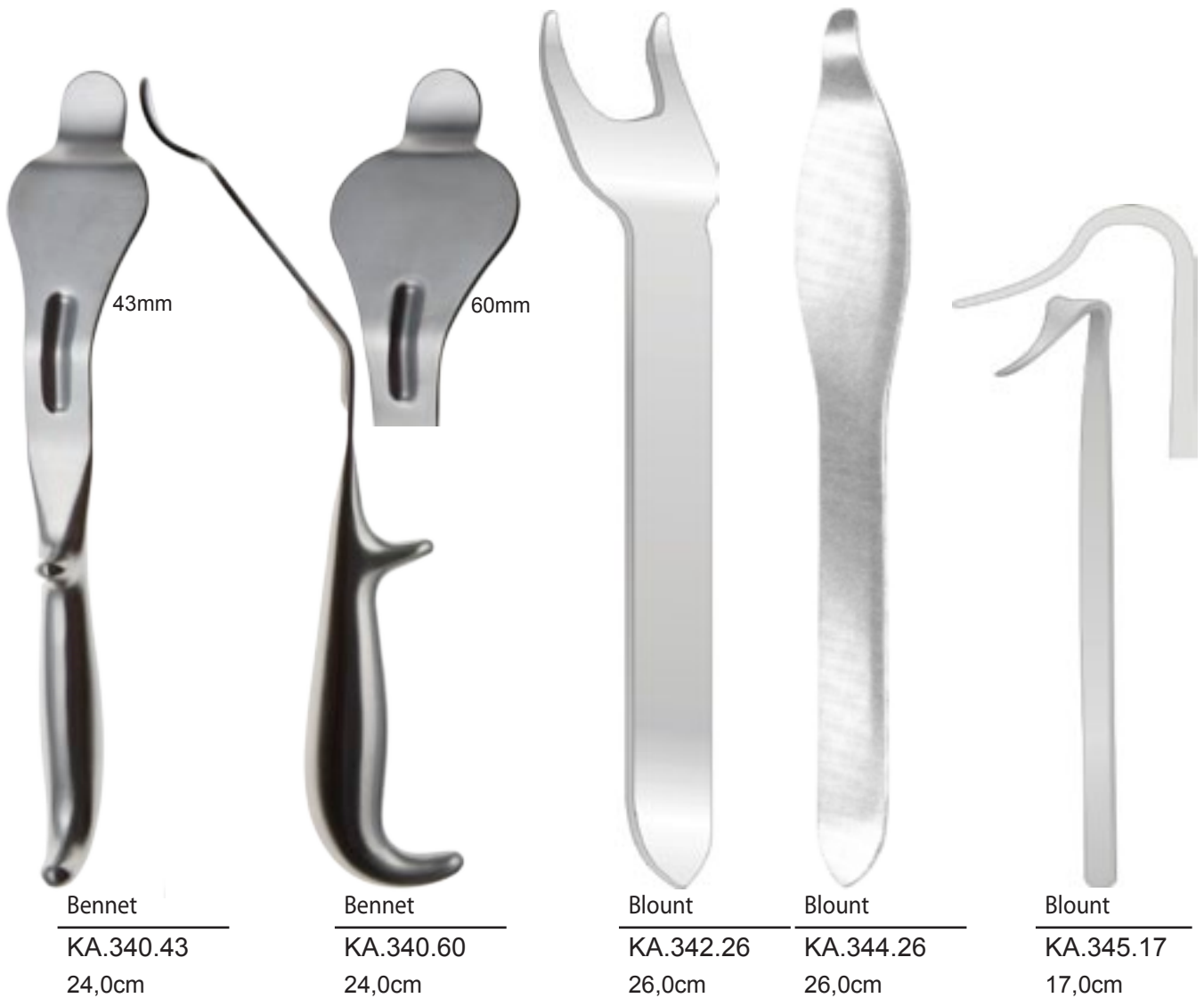

1:2

KA



Putti

KA.501.30
30,0cm



Putti

KA.502.27
27,0cm



Knochenfeile

KA.510.29
29,5cm



13 mm

Knochenfeile

KA.514.24
24,5cm



Knochenfeile

KA.516.22
22,0cm

**HÄMMER
MALLETS**

MARTILLOS Y MAZOS
MAILLETS
MARTELLI

KB



Ganzmetall 360g

Article No.	Size
KB.204.20	20,0cm



Collin 220g / Ø 30mm

Article No.	Size
KB.208.20	20,0cm



Lucae 260g / Ø 25mm

Article No.	Size
KB.210.02	19,5cm



Hajek 140g (Kopf) / Ø 27mm

Article No.	Size
KB.210.19	21,5cm



Doyen / 21,0cm

Article No.	Weight
KB.212.01	120g
KB.212.02	180g
KB.212.03	260g

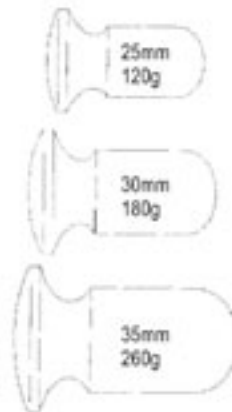

Partsch 200g / Ø 22mm

Article No.	Size
KB.214.19	18,0cm



Williger / 24,0cm

Article No.	Weight
KB.216.01	300g
KB.216.02	340g
KB.216.03	400g

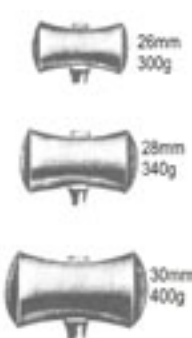
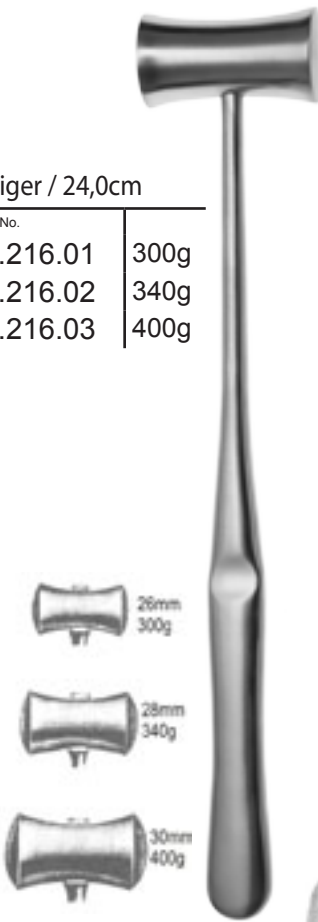

Hammer 530g
 Ø 30/40mm

Article No.	Size
KB.220.26	26,0cm

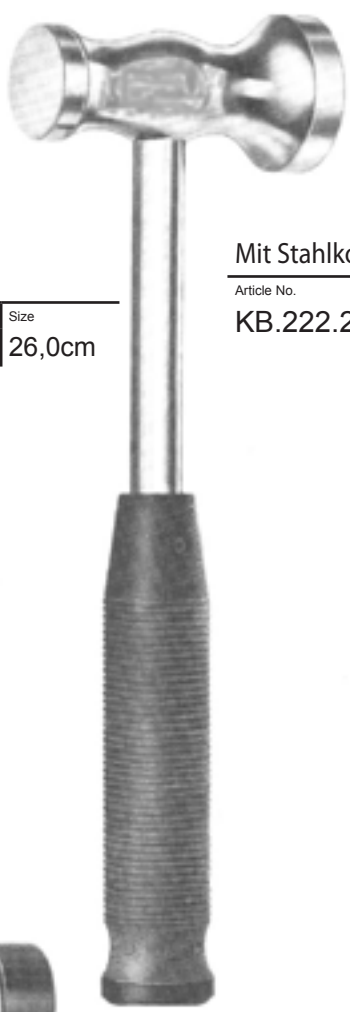

Mit Stahlkopf / Ø 30mm

Article No.	Size
KB.222.24	24,0cm



Mit Wechselbern Backen
 370g / Ø 37mm

Article No.	Size
KB.224.22	22,5cm

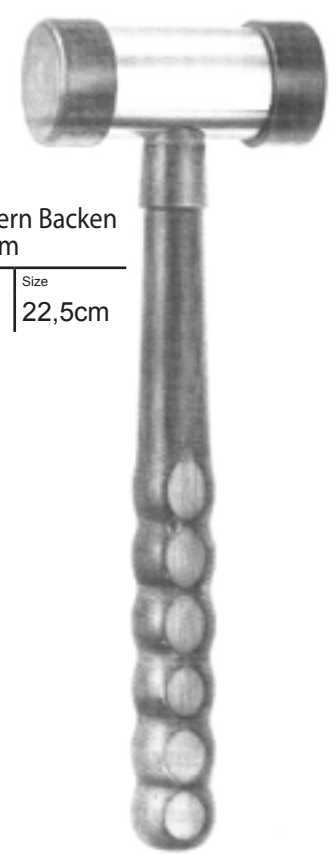

Ersatzbacken paar
 Ø 37mm

Article No.	Size
KB.224.90	



**HÄMMER
MALLETS**

MARTILLOS Y MAZOS
MAILLETS
MARTELLI

KB



40mm
700g

Heath 700g / Ø 40mm

Article No.	Size
KB.230.18	18,5cm



40mm
550g

550g / Ø 40mm

Article No.	Size
KB.232.18	18,0cm



50mm
900g

900g / Ø 50mm

Article No.	Size
KB.234.18	18,0cm



40mm
550g

Omredanne 550g

Article No.	Size
KB.235.24	24,0cm



Omredanne 1200g

Article No.
KB.235.99



Rückschlagfrei

Article No.	Size
KB.238.29	27,0cm



Ferozell / Stahl
 26,5cm

Article No.	
KB.240.01	450g
KB.240.02	900g



Bergmann / Ø 50mm

Article No.	Size
KB.242.23	23,5cm

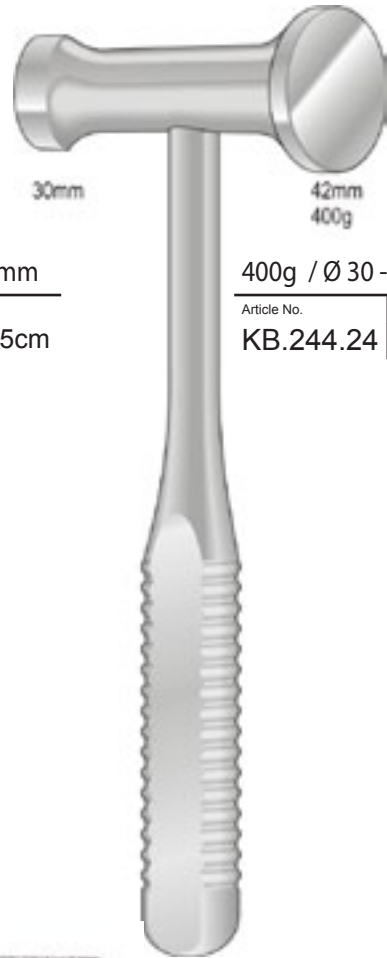

30mm

42mm
 400g

400g / Ø 30 - 42mm

Article No.	Size
KB.244.24	24,0cm



45mm
 300g

Bergmann
 300g / Ø 45mm

Article No.	Size
KB.246.24	24,5cm

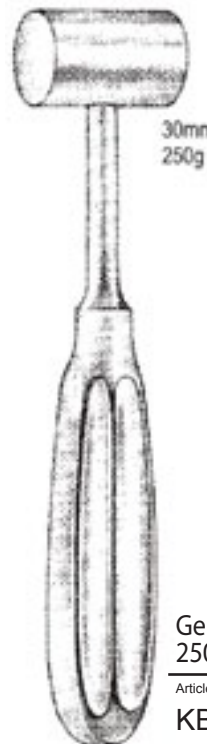

30mm
 250g

Gerzog
 250g / Ø 30mm

Article No.	Size
KB.250.19	19,5cm

**HÄMMER
MALLETS**

MARTILLOS Y MAZOS
MAILLETS
MARTELLI

KB

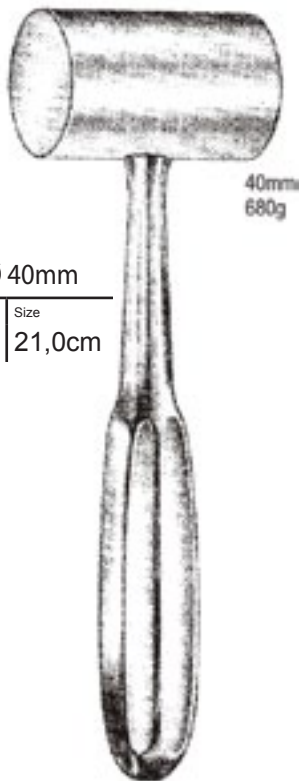

Kirk 680g / Ø 40mm

Article No.	Size
KB.250.21	21,0cm



Spezial Hammer
24,0cm

Article No.	Weight
KB.254.01	350g
KB.254.02	500g
KB.254.03	700g



20mm
200g

Bleifüllung Ø 22mm

Article No.	Size
KB.260.16	16,0cm



Ersatzbacken
1 Paar
KB.262.90

Kunststoffbacken
140g / Ø 25mm

Article No.	Size
KB.262.19	19,0cm



1Seite flach
1Seite konvex
1side flat
1side convex

Cottle 240g / Ø30mm

Article No.	Size
KB.264.19	19,0cm



20mm
320g

Ersatzbacken
1 Paar
KB.266.90

Mead 320g / Ø26mm

Article No.	Size
KB.266.18	18,0cm

Ferrozell Hammer



35x55mm
KB.276.06



45x70mm
KB.276.16



50x80mm
KB.276.26



42x70mm
KB.278.26

HÄMMER
MALLETS

MARTILLOS Y MAZOS
MAILLETS
MARTELLI

KB

300g / Ø 27mm

Article No.	Size
KB.283.30	24,0cm



500g

Article No.	Size
KB.283.50	24,0cm



700g

Article No.	Size
KB.283.70	24,0cm



Silikon Rundgriff

Ersatzbacken
Pair of spare disks

Article No.
KB.284.66

250g / Ø 30mm

Article No.	Size
KB.284.48	24,0cm



Schlitzhammer rund

Article No.
KB.400.30





13,5cm

- KC.050.08 = 8mm
- KC.050.10 = 10mm
- KC.050.12 = 12mm
- KC.050.14 = 14mm
- KC.050.16 = 16mm



13,5cm

- KC.051.08 = 8mm
- KC.051.10 = 10mm
- KC.051.12 = 12mm
- KC.051.14 = 14mm
- KC.051.16 = 16mm



13,5cm

- KC.052.08 = 8mm
- KC.052.10 = 10mm
- KC.052.12 = 12mm
- KC.052.14 = 14mm
- KC.052.16 = 16mm



Partsch



13,5cm

- KC.060.02 = 2mm
- KC.060.03 = 3mm
- KC.060.04 = 4mm
- KC.060.05 = 5mm
- KC.060.06 = 6mm



17cm

- KC.060.02 = 2mm
- KC.060.03 = 3mm
- KC.060.04 = 4mm
- KC.060.05 = 5mm
- KC.060.06 = 6mm



13,5cm

- KC.062.02 = 2mm
- KC.062.03 = 3mm
- KC.062.04 = 4mm
- KC.062.05 = 5mm
- KC.062.06 = 6mm



17cm

- KC.063.02 = 2mm
- KC.063.03 = 3mm
- KC.063.04 = 4mm
- KC.063.05 = 5mm
- KC.063.06 = 6mm

MEISSEL & OSTEOTOME
CHISELS AND GOUGES

OSTEÓTOMES, CINSELES, GUBIAS
OSTÉOTOMES, CISEAUX-BURINS, GUBIAS
OSTEOTOMI, SCALPELLI

KC

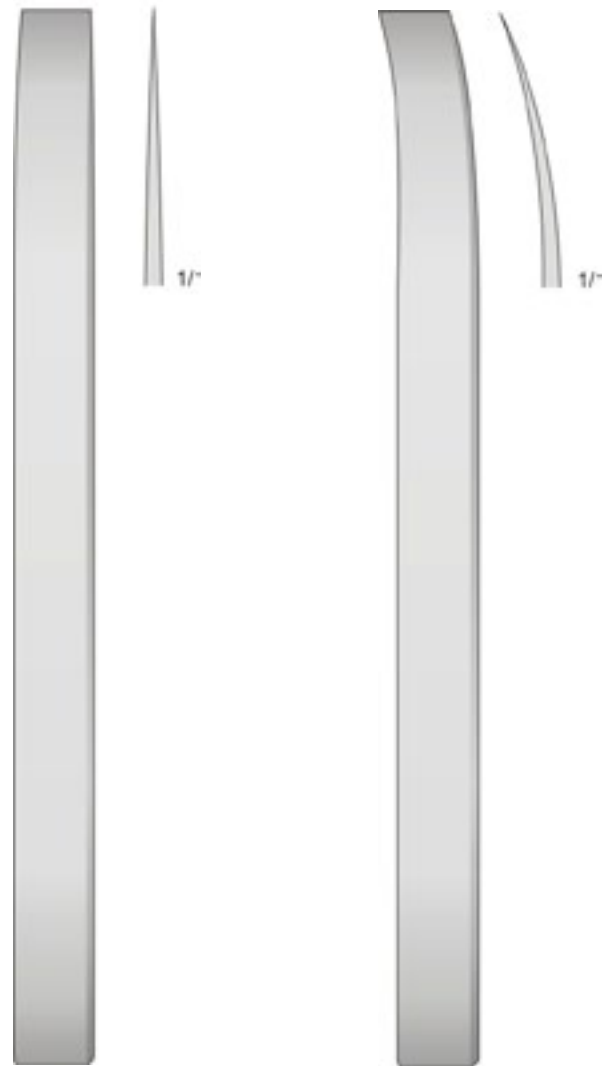
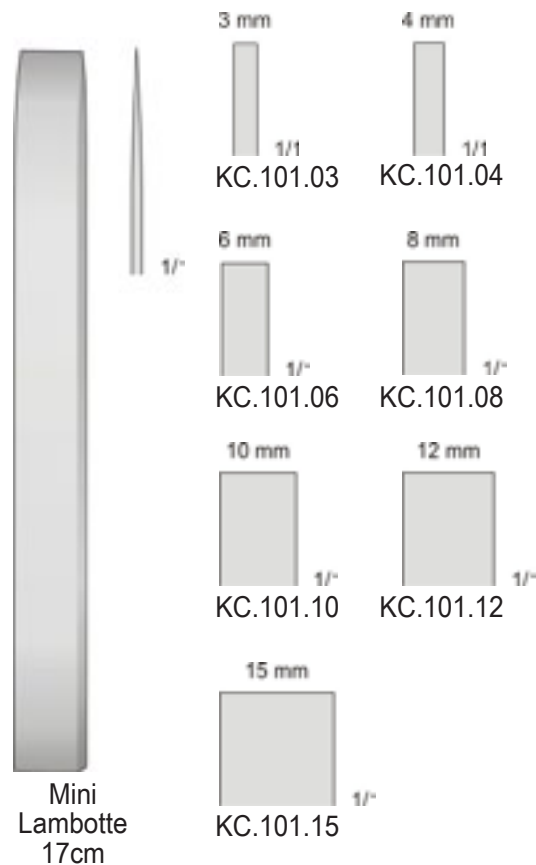
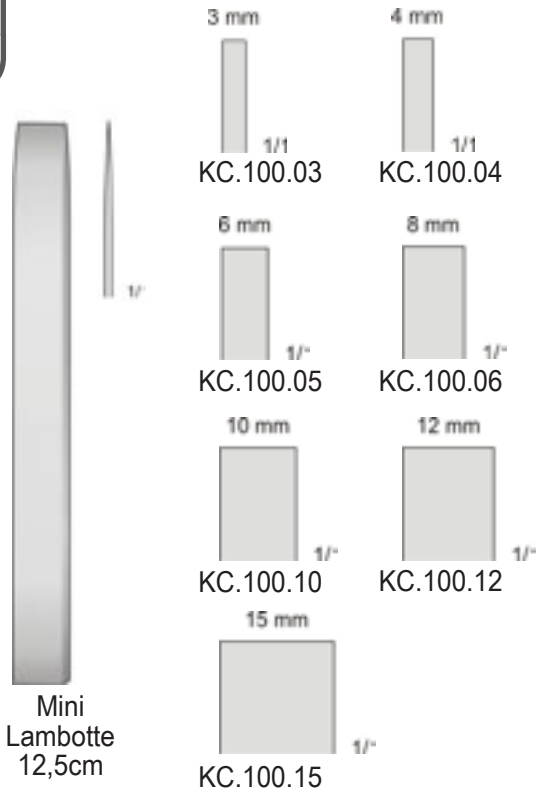

Lambotte 24cm		
KC.102.04	4,0mm	
KC.102.06	6,5mm	
KC.102.08	8,0mm	KC.103.08
KC.102.10	10,0mm	KC.103.10
KC.102.13	13,0mm	KC.103.13
KC.102.15	15,0mm	KC.103.15
KC.102.18	18,0mm	KC.103.18
KC.102.20	20,0mm	KC.103.20
KC.102.25	25,0mm	KC.103.25
KC.102.30	30,0mm	KC.103.30
KC.102.38	38,0mm	KC.103.38
KC.102.44	44,0mm	KC.103.44
KC.102.50	50,0mm	KC.103.50

Andere Modelle auf Anfrage
Other patterns on request
Otros modelos sobre demanda
Autres modèles sur demande

DELICATE-OSTEOTOM MEISSEL
MEDE-SPECIAL
16,5cm

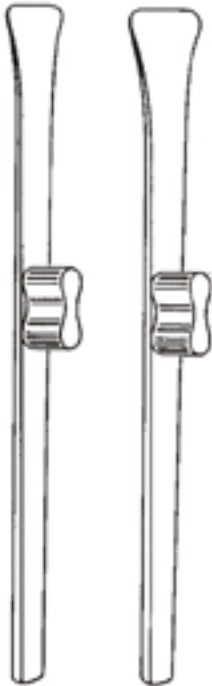

- KC.104.06 = 6mm
- KC.104.08 = 8mm
- KC.104.10 = 10mm
- KC.104.12 = 12mm
- KC.104.14 = 14mm

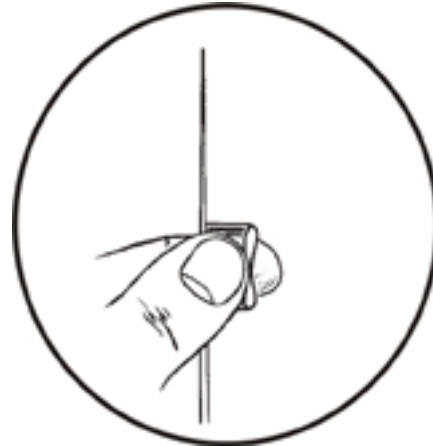

Mit Fingergriff / with finger stabilizer

MINI-MEISSEL
MEDE-SPECIAL
12,5cm



KC.105.04 = 4mm



KC.105.06 = 6mm



KC.105.08 = 8mm



KC.105.10 = 10mm



KC.105.12 = 12mm

MINI LEXER MEISSEL
CHISELS. GOUGES WITH FERROZELL-HANDLE

CINCELES, GUBIAS
 CISEAUX-BURINS ET OSTÉOTOMES
 SCAPELLI E OSTEOTOMI

KC

Lieferbar auch Sonderabmessungen
 Also available in special sizes
 También obtenible en tamanos especiales
 Aussi livrable en mesures spéciales



Mini-Lexer
18cm

Mini-Lexer
18cm

Mini-Lexer
18cm

- KC.110.04 = 4mm
- KC.110.06 = 6mm
- KC.110.08 = 8mm
- KC.110.10 = 10mm
- KC.110.12 = 12mm
- KC.110.15 = 15mm

- KC.111.04 = 4mm
- KC.111.06 = 6mm
- KC.111.08 = 8mm
- KC.111.10 = 10mm
- KC.111.12 = 12mm
- KC.111.15 = 15mm

- KC.112.04 = 4mm
- KC.112.06 = 6mm
- KC.112.08 = 8mm
- KC.112.10 = 10mm
- KC.112.12 = 12mm
- KC.112.15 = 15mm

Lieferbar auch Sonderabmessungen
Also available in special sizes
También obtenible en tamanos especiales
Aussi livrable en mesures spéciales



Lexer
22cm

KC.114.05 = 5mm
KC.114.07 = 7mm
KC.114.10 = 10mm
KC.114.15 = 15mm
KC.114.20 = 20mm
KC.114.25 = 25mm
KC.114.30 = 30mm



Lexer
22cm

KC.115.05 = 5mm
KC.115.07 = 7mm
KC.115.10 = 10mm
KC.115.15 = 15mm
KC.115.20 = 20mm
KC.115.25 = 25mm
KC.115.30 = 30mm

LEXER MEISSEL
OSTEOTOMES, CHISLES, GOUGES

OSTEÓTOMES, CHINCELES, GUBIAS
 CISEAUX-BURINS ET OSTÉOTOMES
 SCALPELLI E OSTEOTOMI

KC

Lieferbar auch Sonderabmessungen
 Also available in special sizes
 También obtenible en tamanos especiales
 Aussi livrable en mesures spéciales



abgewinkelt
 angled

Lexor Meissel - Osteotom 30cm

Article No.	Size
KC.116.07	7mm
KC.116.10	10mm
KC.116.15	15mm
KC.116.20	20mm
KC.116.25	25mm
KC.116.30	30mm

Dahmen Meissel 30cm

Article No.	Size
KC.116.57	7mm
KC.116.60	10mm
KC.116.65	15mm
KC.116.70	20mm
KC.116.75	25mm
KC.116.80	30mm

Lieferbar auch Sonderabmessungen
Also available in special sizes
También obtenible en tamanos especiales
Aussi livrable en mesures spéciales



Lexer Hohlmeissel 30cm

Article No.	Size
KC.117.07	7mm
KC.117.10	10mm
KC.117.15	15mm
KC.117.20	20mm
KC.117.25	25mm
KC.117.30	30mm

Lexer Meisselform 30cm

Article No.	Size
KC.118.07	7mm
KC.118.10	10mm
KC.118.15	15mm
KC.118.20	20mm
KC.118.25	25mm
KC.118.30	30mm

SPEZIAL HOHL- & SCHWANENHALSMEISSEL
OSTEOTOMES, CHISLES, GOUGES

OSTEÓTOMES, CHINCELES, GUBIAS
CISEAUX-BURINS ET OSTÉOTOMES
SCALPELLI E OSTEOTOMI

KC

Specialrillengriff
und Splitterfreuem
Metallende

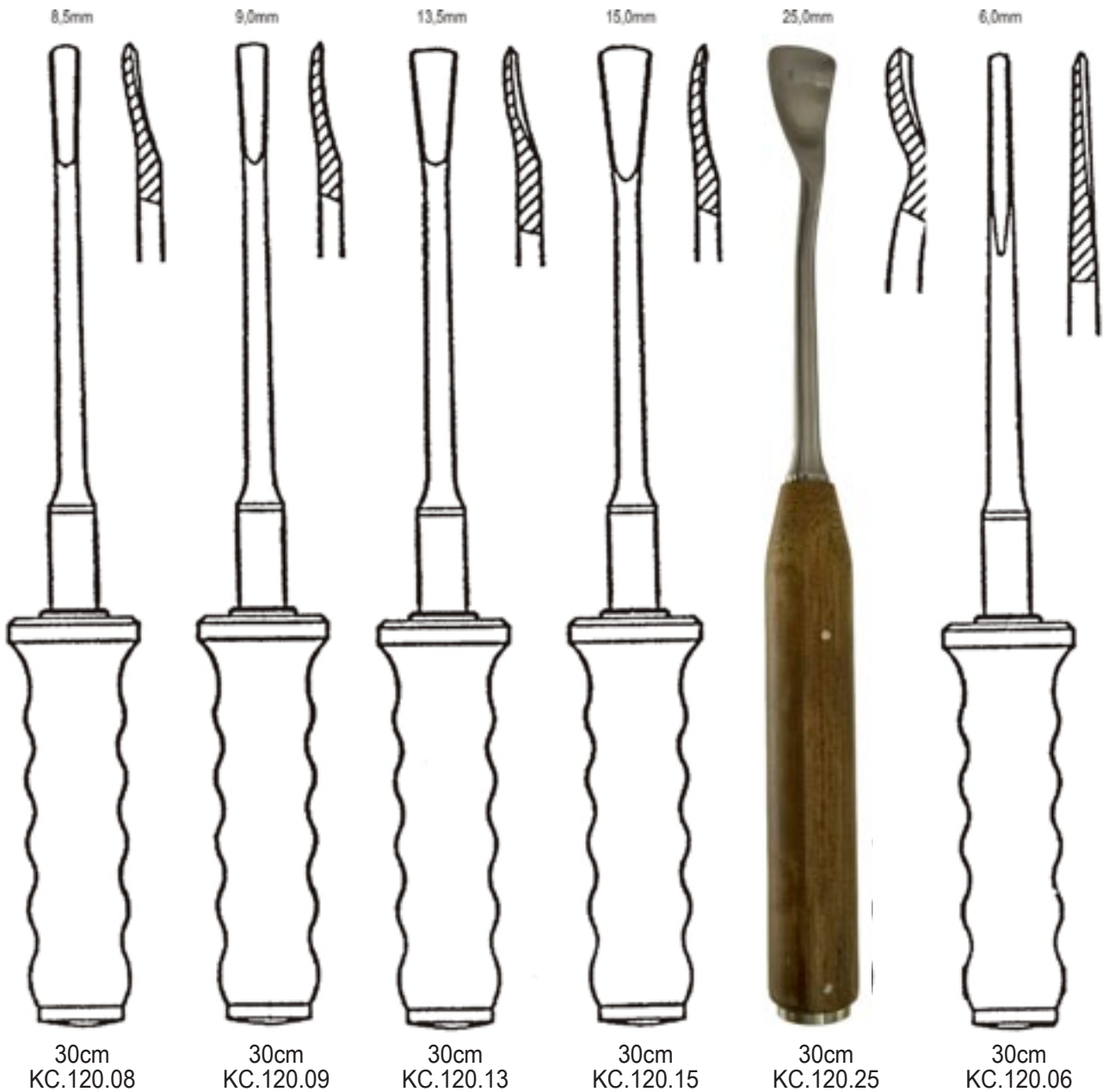



18cm
 KC.125.01

18cm
 KC.125.00

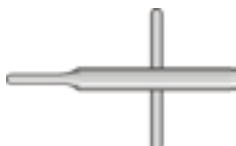

KC.125.10

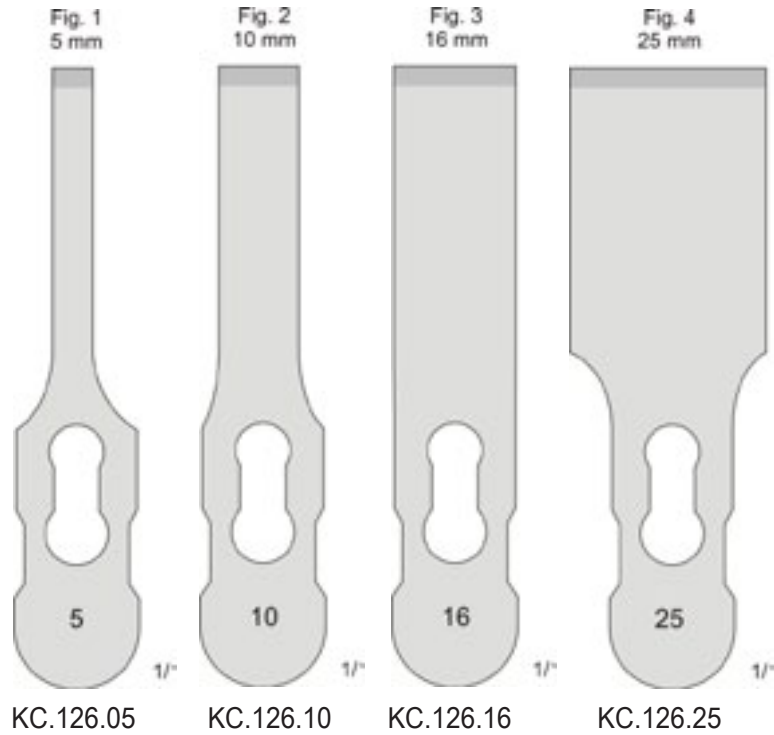

Osteotom
 Gouge
 Gubias
 Gouges
 Osteotomi

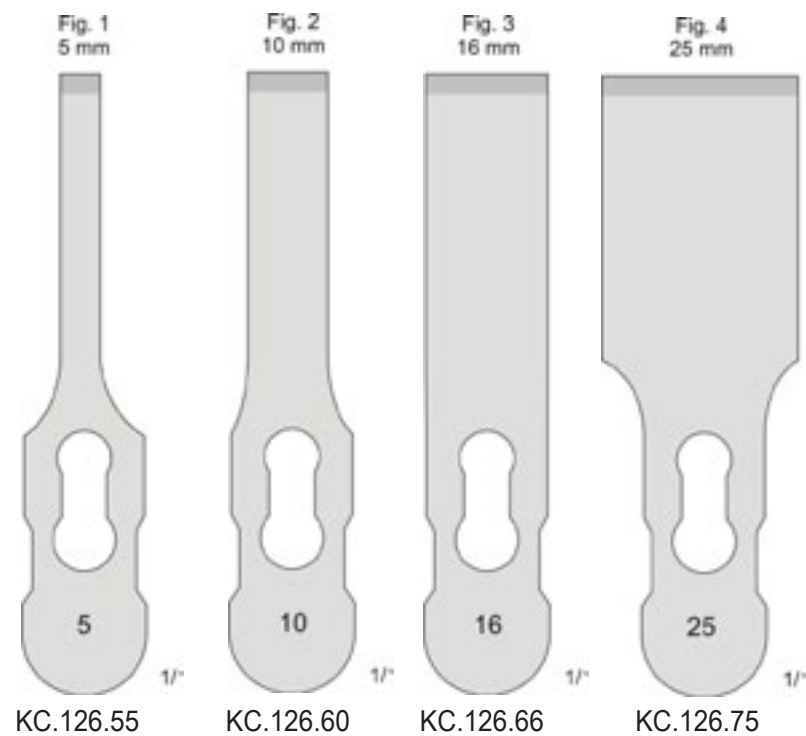

Meißel
 Chisel
 Cinceles
 Ciseaux-burins
 Scalpelli

STILLE MEISSEL & OSTEOTOME
OSTEOTOMES, CHISLES, GOUGES

OSTEÓTOMES, CHINCELES, GUBIAS
 CISEAUX-BURINS ET OSTÉOTOMES
 SCALPELLI E OSTEOTOMI

KC

Meißel/Chisel/Cinseles/Ciseaux-burins/ScalPELLi



KC.170.10 = 10mm
 KC.170.15 = 15mm
 KC.170.20 = 20mm
 KC.170.25 = 25mm

Stille
 20cm

Osteotom/Gouge/Gubias/Gougues/Osteotomi



KC.171.10 = 10mm
 KC.171.15 = 15mm
 KC.171.20 = 20mm
 KC.171.25 = 25mm

Stille
 20cm



KC.172.10 = 10mm
 KC.172.15 = 15mm
 KC.172.20 = 20mm
 KC.172.25 = 25mm

Stille
 20cm

Meissel zum Freilegen
abgebrochener Schrauben



Lexer
22cm



Spongiosa Meissel
25cm

5mm
KC.204.05

10mm
KC.204.10

15mm
KC.204.15

5mm
KC.205.05

10mm
KC.205.10

15mm
KC.205.15



Spongiosa Meisse
25cm

HOHLMEISSEL
OSTEOTOMES, CHISLES, GOUGES

OSTEÓTOMES, CHINCELES, GUBIAS
CISEAUX-BURINS ET OSTÉOTOMES
SCALPELLI E OSTEOTOMI

KC



Zielke
23cm
KC.208.55 = 5,5mm
KC.208.90 = 9,0mm

COOB
28cm
KC.210.01

COOB
28cm
KC.210.02

COOB
28cm
KC.210.03

COOB
28cm
KC.210.04

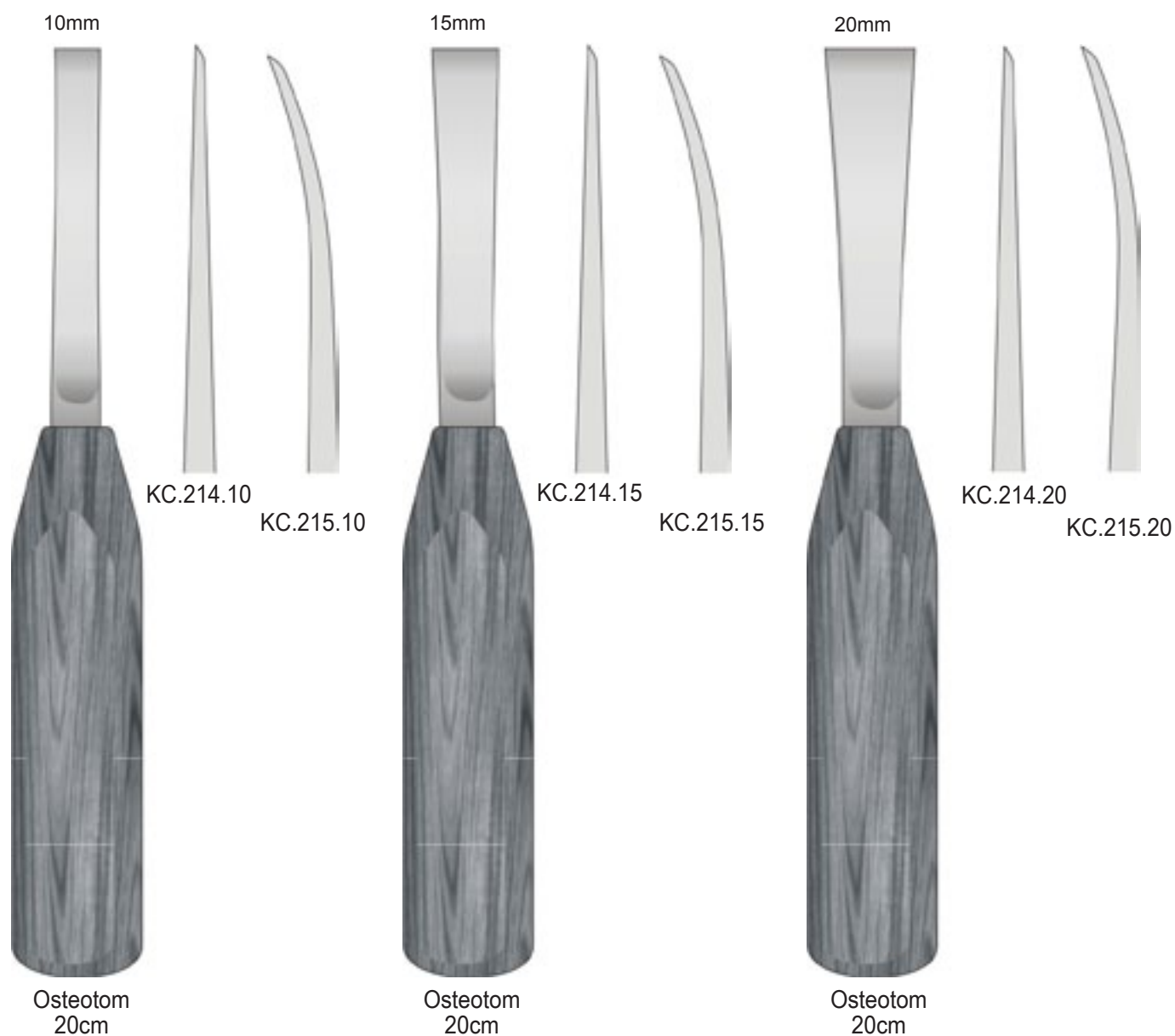

SMITH-PETERSEN MEISSEL
OSTEOTOMES, CHISLES, GOUGES

OSTEÓTOMES, CHINCELES, GUBIAS
 CISEAUX-BURINS ET OSTÉOTOMES
 SCALPELLI E OSTEOTOMI



Smith-Petersen
20cm



Smith-Petersen
20cm



Smith-Petersen
20cm



Smith-Petersen
20cm

6mm	KC.220.06
9mm	KC.220.09
13mm	KC.220.13
14mm	
16mm	KC.220.16
19mm	KC.220.19
25mm	KC.220.25
32mm	KC.220.32

KC.222.06
KC.222.09
KC.222.13
KC.222.16
KC.222.19
KC.222.25
KC.222.32

KC.223.09
KC.223.14
KC.223.19
KC.223.25
KC.223.32

KC.225.09
KC.225.14
KC.225.19
KC.225.25
KC.225.32



16mm

Flachmeissel
gebogene Schneidplatte
32cm
KC.251.16



9mm

Schmaler Meissel
gebogen
27cm
KC.141.09



Joseph Säge

MEISSEL & OSTEOTOME
CHISELS AND GOUGES

OSTEÓTOMES, CINSELES, GUBIAS
OSTÉOTOMES, CISEAUX-BURINS, GUBIAS
OSTEOTOMI, SCALPELLI

KC



Silver Meissel
gerade
18cm
KC.870.01



Silver Meissel
links gebogen
18cm
KC.870.02



Silver Meissel
rechts gebogen
18cm
KC.870.03



Syfert
38cm

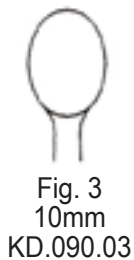
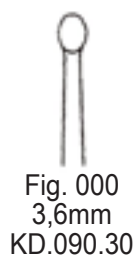
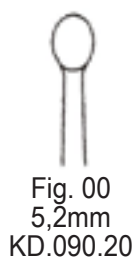
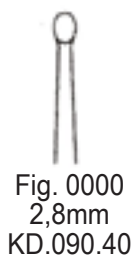

Syfert
38cm

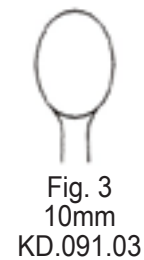
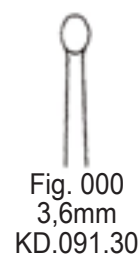
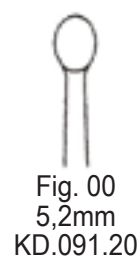

SCHARFE LÖFFEL
BONE CURETTES

CUCHARILLAS CORTANTES
CURETTES
CURETTE TAGLIANTI

KD



Syptert
42cm



Fig. 0000
2,8mm
KD.092.40



Fig. 000
3,6mm
KD.092.30



MEDE Spezial
41cm



Fig. 000
3,6mm
KD.095.30



Fig. 00
4,4mm
KD.095.20



Fig. 0
5,2mm
KD.095.10



MEDE Spezial
41cm



Fig. 000
3,6mm
KD.096.30



Fig. 00
4,4mm
KD.096.20



Fig. 0
5,2mm
KD.096.10



27cm



Fig.00
4,4mm
KD.102.00



Fig.1
6,8mm
KD.102.01



Fig.2
8,5mm
KD.102.02



Fig.3
8,5mm
KD.102.02



Caspar
22cm



gebogen / curved



Fig.000
3,6mm
KD.103.30



Fig.000
3,6mm
KD.104.30



Fig.00
4,4mm
KD.103.20



Fig.00
4,4mm
KD.104.20



Fig.0
5,2mm
KD.103.10



Fig.0
5,2mm
KD.104.10

SCHARFE LÖFFEL
BONE CURETTES

CUCHARILLAS CORTANTES
CURETTES
CURETTE TAGLIANTI

KD



Scheide
17cm

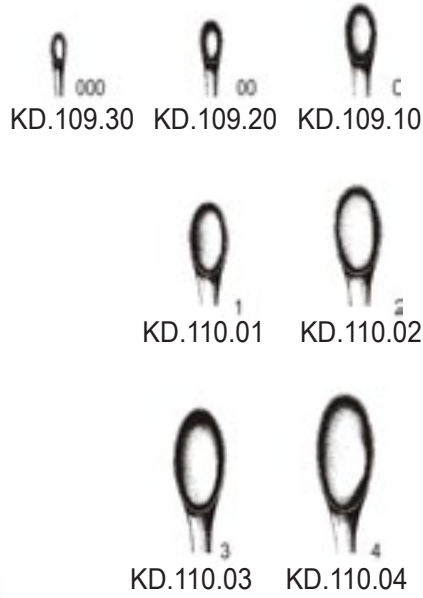

Bruns
16,5cm

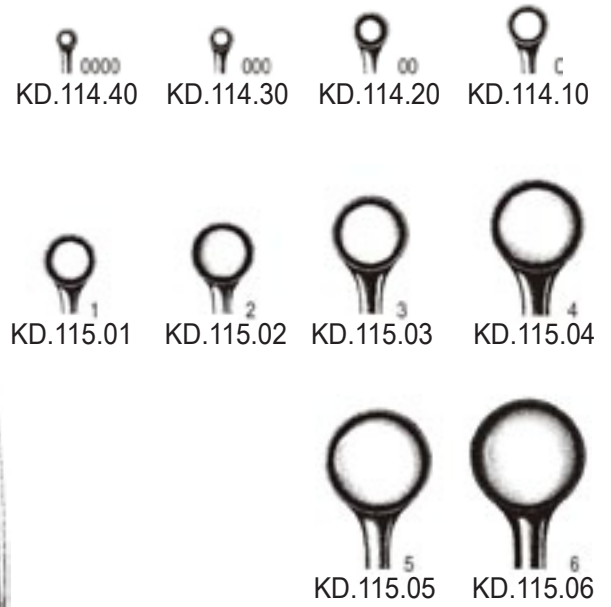

Volkmann
17cm

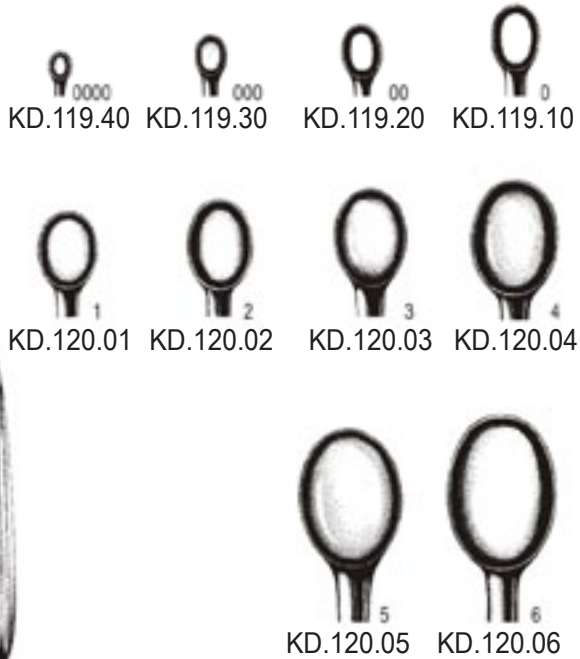

Spratt
16cm

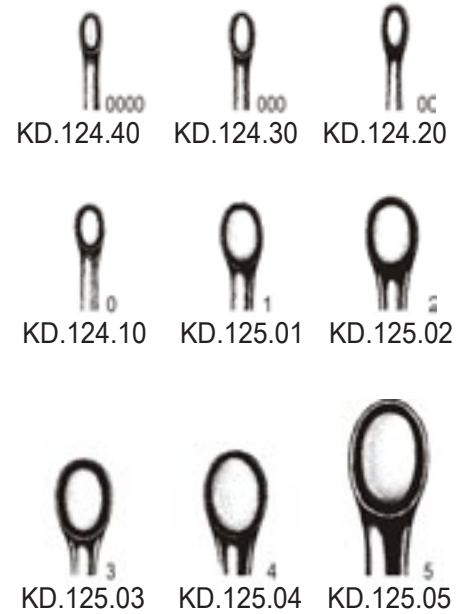

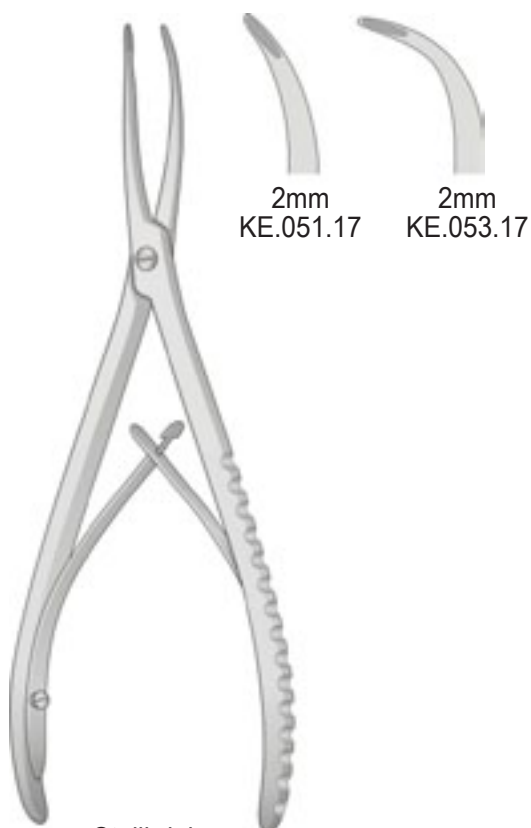

Stellbrink
17cm



Friedmann
15cm



Cleveland
16cm
KE.073.17



Hartmann
18,5cm
KE.085.18



Mead
16cm
KE.101.16

HOHLMEISSELZANGEN
BONE RONGEURS

PINZAS-GUBIAS
PINCES-GOUGES
PINZE-SGORBIE

KE



Mini-Friedmann
12cm
KE.061.12



Friedmann
14cm
KE.063.14



Blumenthal
15,5cm
KE.120.01



Cleveland
14cm
KE.071.14



Mead
16,5cm
KE.081.16



Janson
18cm
KE.108.18



Luer
 17cm



Lempert
 16 + 19cm



16cm



KE.114.19

19cm

KE.115.19



Adson
 20cm
 KE.124.20



Olivercrona
 20cm
 KE.127.20



Luer
 15cm



KE.135.15 KE.137.15 KE.139.15

HOHLMEISSELZANGEN
BONE RONGEURS

PINZAS-GUBIAS
PINCES-GOUGES
PINZE-SGORBIE

KE

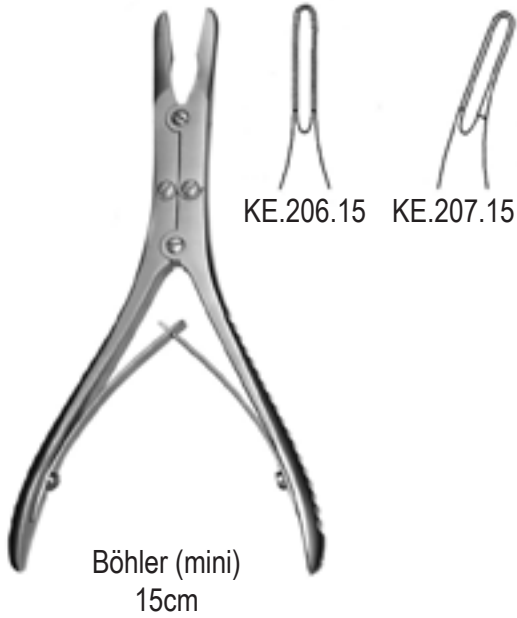

HOHLMEISSELZANGEN
BONE RONGEURS



Röttgen-Ruskin
 23cm
 KE.227.23



Stille-Luer
 22cm + 26cm

KE.230.22 = 22cm
 KE.230.26 = 26cm

KE.231.22 = 22cm
 KE.231.26 = 26cm



Stille
 23cm
 KE.240.23



Leksel
 25cm

3mm
 KE.244.03

5mm
 KE.244.05

8mm
 KE.244.08

HOHLMEISSELZANGEN
BONE RONGEURS

PINZAS-GUBIAS
PINCES-GOUGES
PINZE-SGORBIE

KE



Semb
22cm
KE.245.22



KE.247.02 KE.247.03 KE.247.04

Echlin
23cm



Frykhom
23cm
KE.251.23



KE.254.27



Stille-Luer
27cm



KE.255.27



Sauerbruch
30cm



KE.260.30



KE.262.30



Cottle-Kazanijan
19cm
KE.404.19

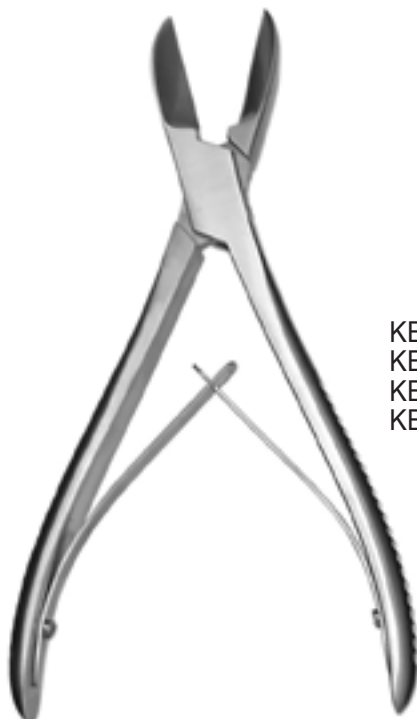

Liston



KE.410.14 = 14cm
KE.410.17 = 17cm
KE.410.19 = 19cm
KE.410.22 = 22cm

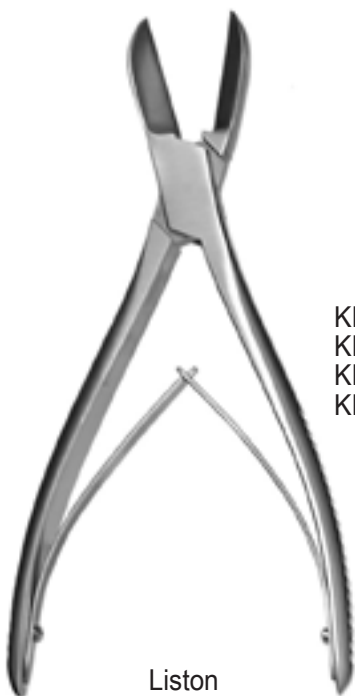

Liston



KE.411.14 = 14cm
KE.411.17 = 17cm
KE.411.19 = 19cm
KE.411.22 = 22cm



Littauer-Liston
16cm
KE.416.16



KNOCHENSPLITTERZANGEN
BONE CUTTING FORCEPS

PINZAS CORTANTES PARA HUESOS
 PINCES COUPANTES À OS
 CESCOIE PER OSSA

KE



Knochenschere
 16cm
 KE.426.16



Knochenschere
 21,5cm
 KE.428.21



KE.450.15



KE.451.15

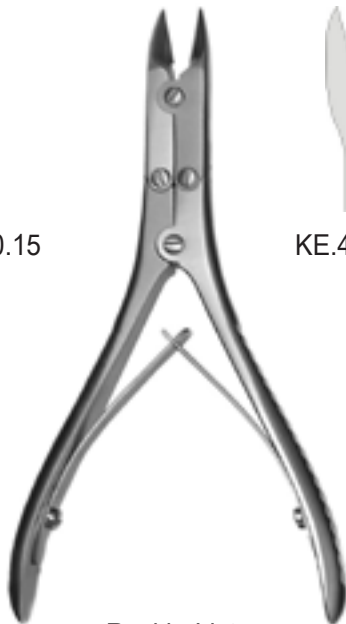

Ruskin-Liston
 18,5cm



KE.458.18



KE.459.18



Böhler
 15cm

PINZAS CORTANTES PARA HUESOS
PINCES COUPANTES À OS
CESOIE PER OSSA

KNOCHENSPLITTERZANGEN BONE CUTTING FORCEPS

KE



MEDE-Kurz
16,5cm
KE.454.16



MEDE-Spezial
18,5cm
KE.458.19

KNOCHENSPLITTERZANGEN
BONE CUTTING FORCEPS

PINZAS CORTANTES PARA HUESOS
 PINCES COUPANTES À OS
 CESCOIE PER OSSA

KE



Stille-Liston
 27cm
 KE.470.27



Stille-Liston
 27cm
 KE.474.27



Stille-Liston
 KE.475.23 = 23cm
 KE.475.27 = 27cm



Liston-Key
 27cm
 KE.480.27



Semb
 24cm
 KE.482.24



Sequesterzange
 20cm

KF.130.20



KF.131.20



Van Buren
 23cm
 KF.135.23

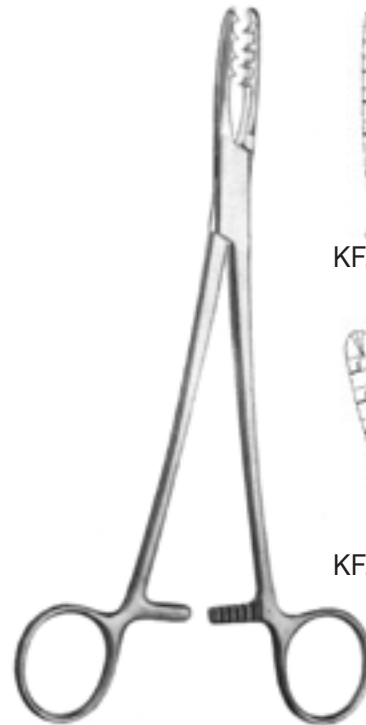

Bircher-Ganske
 20cm

KF.140.20



KF.141.20



Bircher-Ganske
 20cm
 KF.142.20



KF.149.19



KF.149.89



Dingmann
 18,5cm

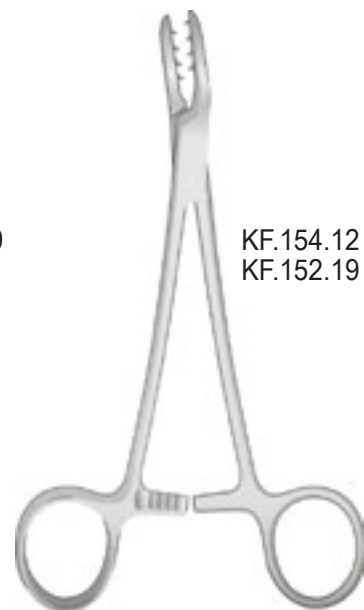

Martin

KF.154.12 = 12cm
 KF.152.19 = 19cm

KNOCHENHALTEZANGEN
BONE HOLDING FORCEPS

PINZAS PARA HUESOS
DAVIERS PORTE-OS
TENAGLIE PER OSSA

KF



Knochenfaßzange
14cm
KF.145.14



Langenbeck Knochenfaßzange
21cm
KF.184.21



Repositionszange
13,5cm
KF.168.90



Setter
16cm
KF.162.16



Setter
24cm
KF.162.24



KF.168.09 = 9cm
KF.168.14 = 14cm



Reil
17cm
KF.169.17

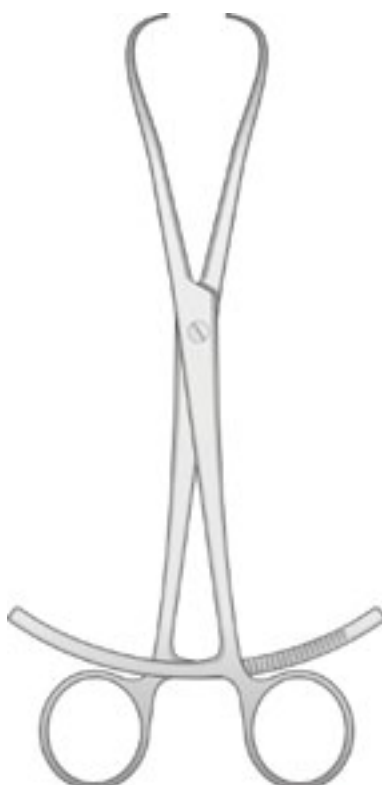

Repositionszange
20cm
KF.170.20



Patella
18,5cm
KF.172.18

KNOCHENHALTEZANGEN
BONE HOLDING FORCEPS

PINZAS PARA HUESOS
DAVIERS PORTE-OS
TENAGLIE PER OSSA

KF



Langenbeck
21cm
KF.180.21



Fergusson
21cm
KF.182.21



20cm
KF.186.20



Kern
KF.200.15 = 15cm
KF.200.17 = 17cm
KF.200.21 = 21cm



Kern
KF.202.15 = 15cm
KF.202.17 = 17cm
KF.202.21 = 21cm

KNOCHENHALTEZANGEN
BONE HOLDING FORCEPS

PINZAS PARA HUESOS
DAVIERS PORTE-OS
TENAGLIE PER OSSA

KF



Lane
KF.204.33 = 33cm
KF.204.45 = 45cm



Lane
KF.205.33 = 33cm
KF.205.45 = 45cm



Semb
19cm
KF.210.19



Semb
19cm
KF.211.19

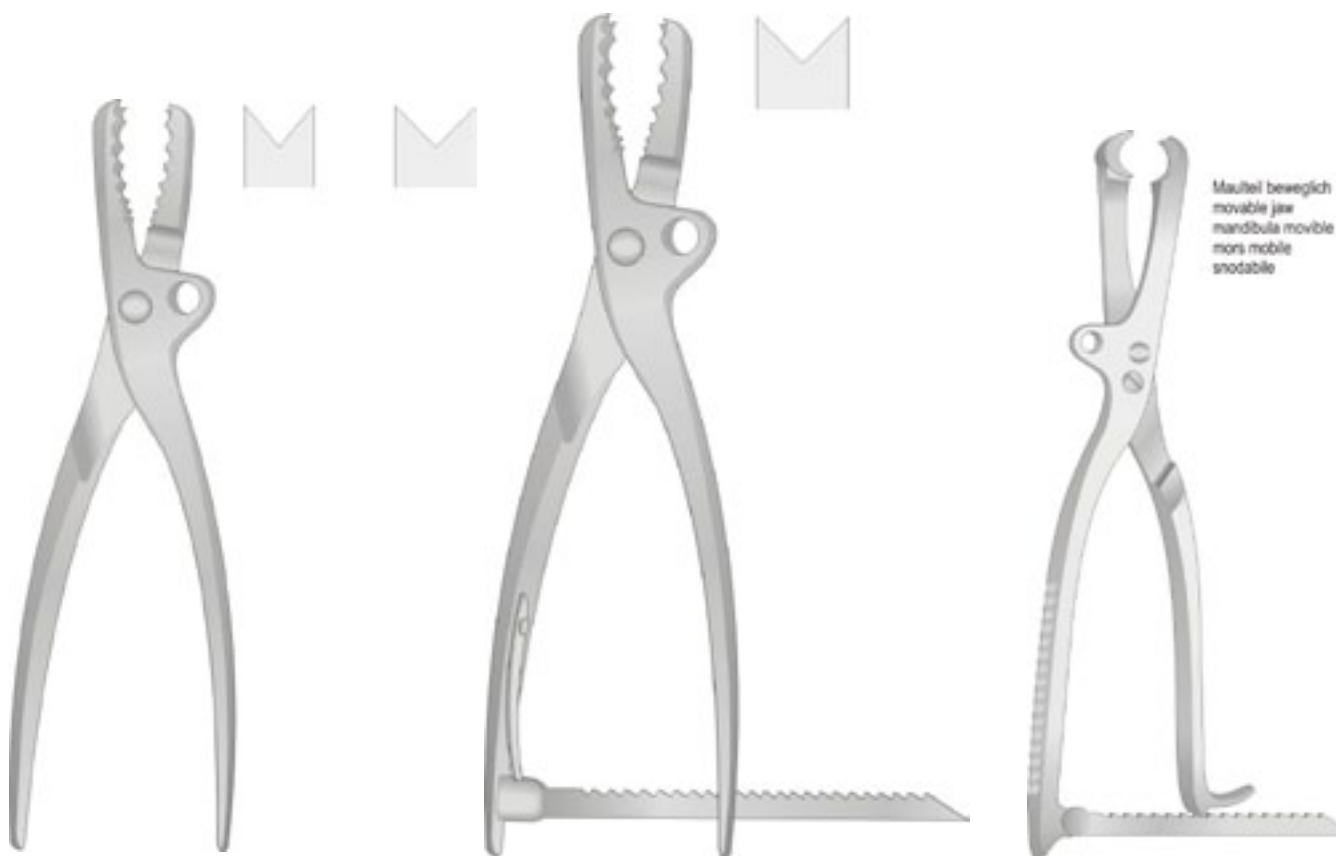

Farabeuf
KF.220.23 = 23cm
KF.220.26 = 26cm

Farabeuf-Lambotte
26cm
KF.224.26

Lambotte
KF.228.22 = 22cm
KF.228.27 = 27cm

KNOCHENHALTEZANGEN
BONE HOLDING FORCEPS

PINZAS PARA HUESOS
DAVIERS PORTE-OS
TENAGLIE PER OSSA

KF



Lambotte
KF.230.22 = 22cm
KF.230.26 = 26,5cm



Lambotte
33cm
KF.232.33



Lambotte
27.5cm
KF.236.28



Lambotte
21.5cm
KF.234.22



KNOCHENHALTEZANGEN
BONE HOLDING FORCEPS

PINZAS PARA HUESOS
DAVIERS PORTE-OS
TENAGLIE PER OSSA

KF

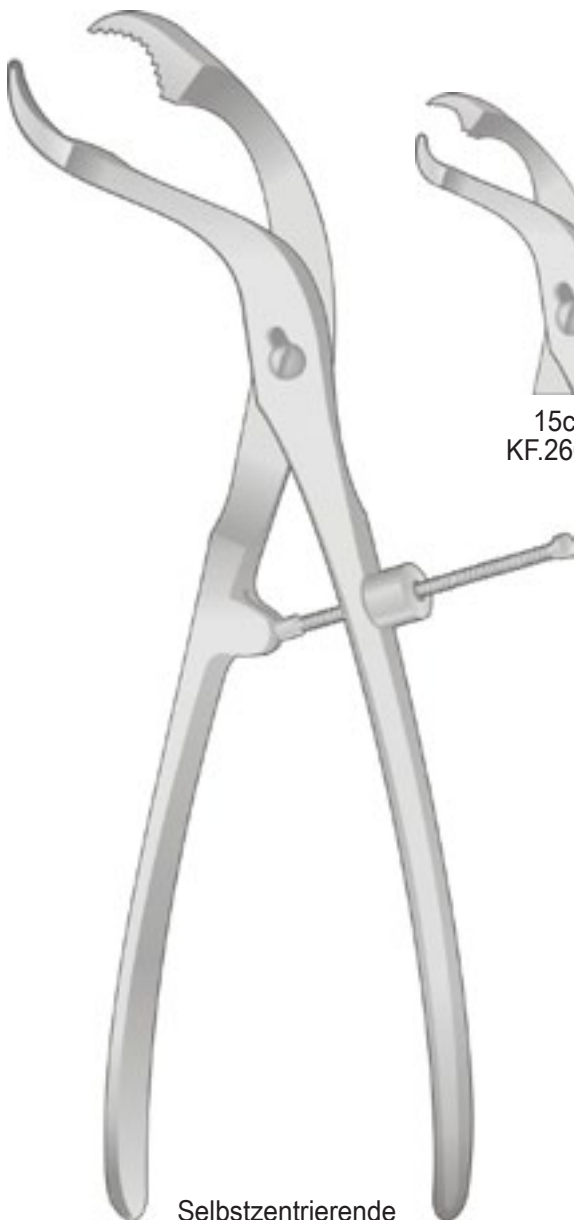

15cm
KF.260.15



19cm
KF.260.19



24cm
KF.260.24



Selbstzentrierende
Knochenhalte-
zange
mit Gewin-
desperre

Self-centering forceps
with thread fixation

fórceps autocentrante con
tope de fijación

á centrage automatique
avec arrêt de filetage

autocentrante con blocco
di filettatura

26cm
KF.260.26



28cm
KF.260.28





Verbrugge

Article No.	Size
KF.280.17	17,5cm



KNOCHENHALTEZANGEN
BONE HOLDING FORCEPS

PINZAS PARA HUESOS
DAVIERS PORTE-OS
TENAGLIE PER OSSA

KF

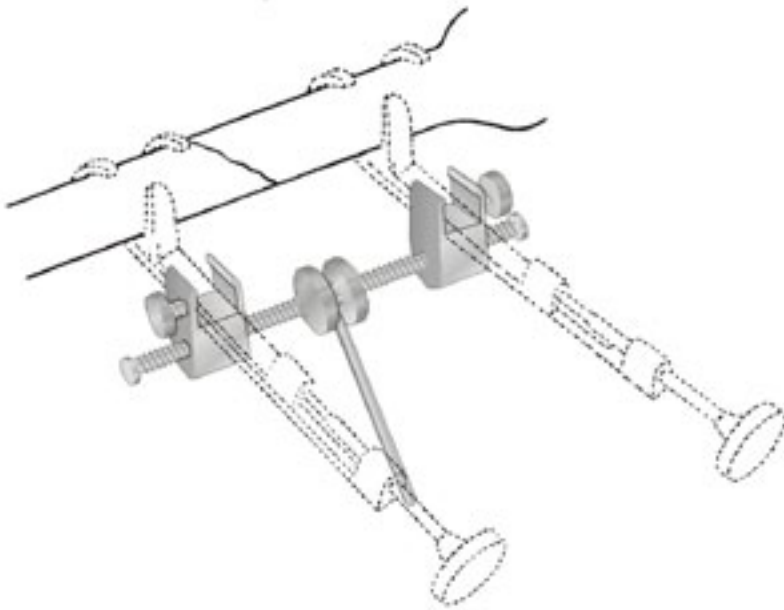

Gerster Distractionsklammer
KF.420.15
passend für Lowman Knochenhalteklammern



Lowman
KF.400.12 = 12cm
KF.400.18 = 18cm
KF.400.20 = 20cm



Knochenfaßzange
26cm



KG.060.00
T-Griff mit
Schnellspannfutter



KG.060.20
T-Griff mit
Schnellspannfutter
und Automatiksicherung



KG.060.50
T-Griff mit
Dreibackenfutter
und Schlüssel



KG.060.91
Dreibackenfutter groß
mit Schlüssel

REIBAHLEN
REAMERS

ESCARIADORES
ALÈNES
PERFORADORES A MANI

KG



14cm
KG.200.14

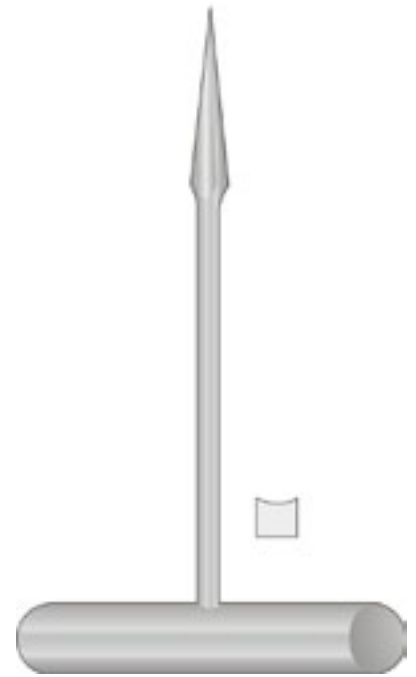

14cm
KG.205.14



Perthes
18cm
KG.206.18



Perthes
21cm
KG.206.21

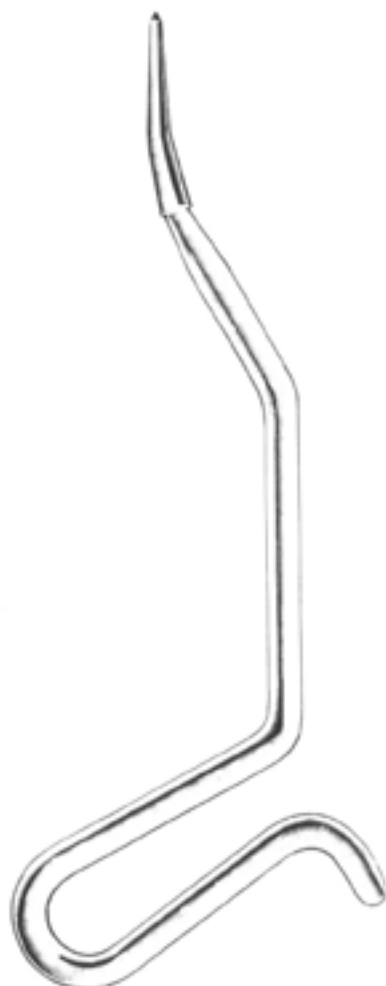

Vorbohrer
KG.216.01



Ausziehhaken
Extractions-Hook
KG.220.29 - 5mm | 29cm
KG.220.37 - 5mm | 37cm
KG.220.43 - 5mm | 43cm
KG.220.51 - 5mm | 51cm

SCHRAUBENDREHER
SCREW DRIVER

DESTORBILLADOR
TOURNEVIS
GIRAVITI

KG

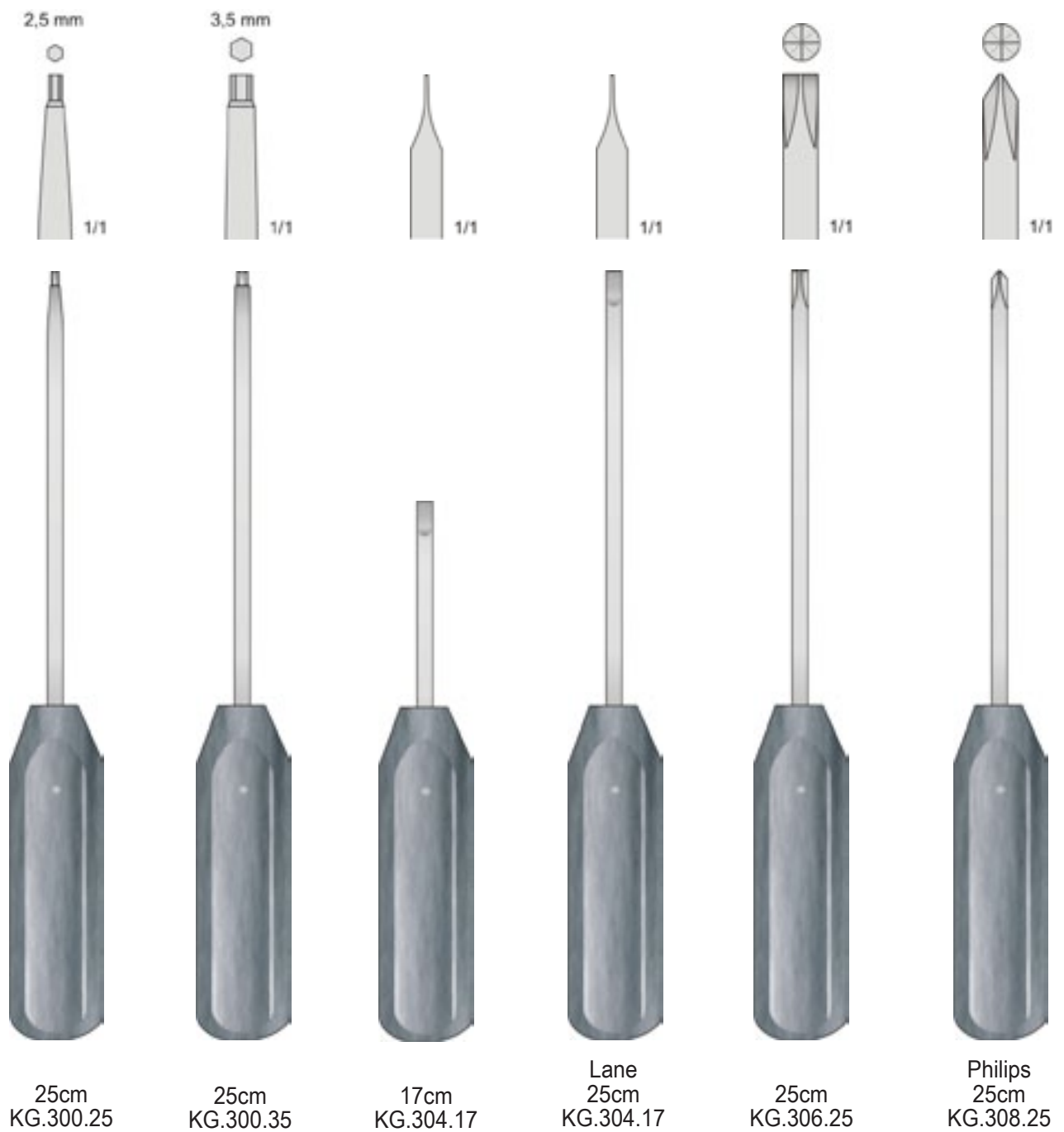



Schraubendreher
mit Kerbe
25cm
KG.303.35



Schraubendreher
mit Hülse
25cm
KG.303.65



Hülse
alleine
KG.303.69

SCHRAUBENDREHER
SCREW DRIVER

DESTORBILLADOR
TOURNEVIS
GIRAVITI

KG

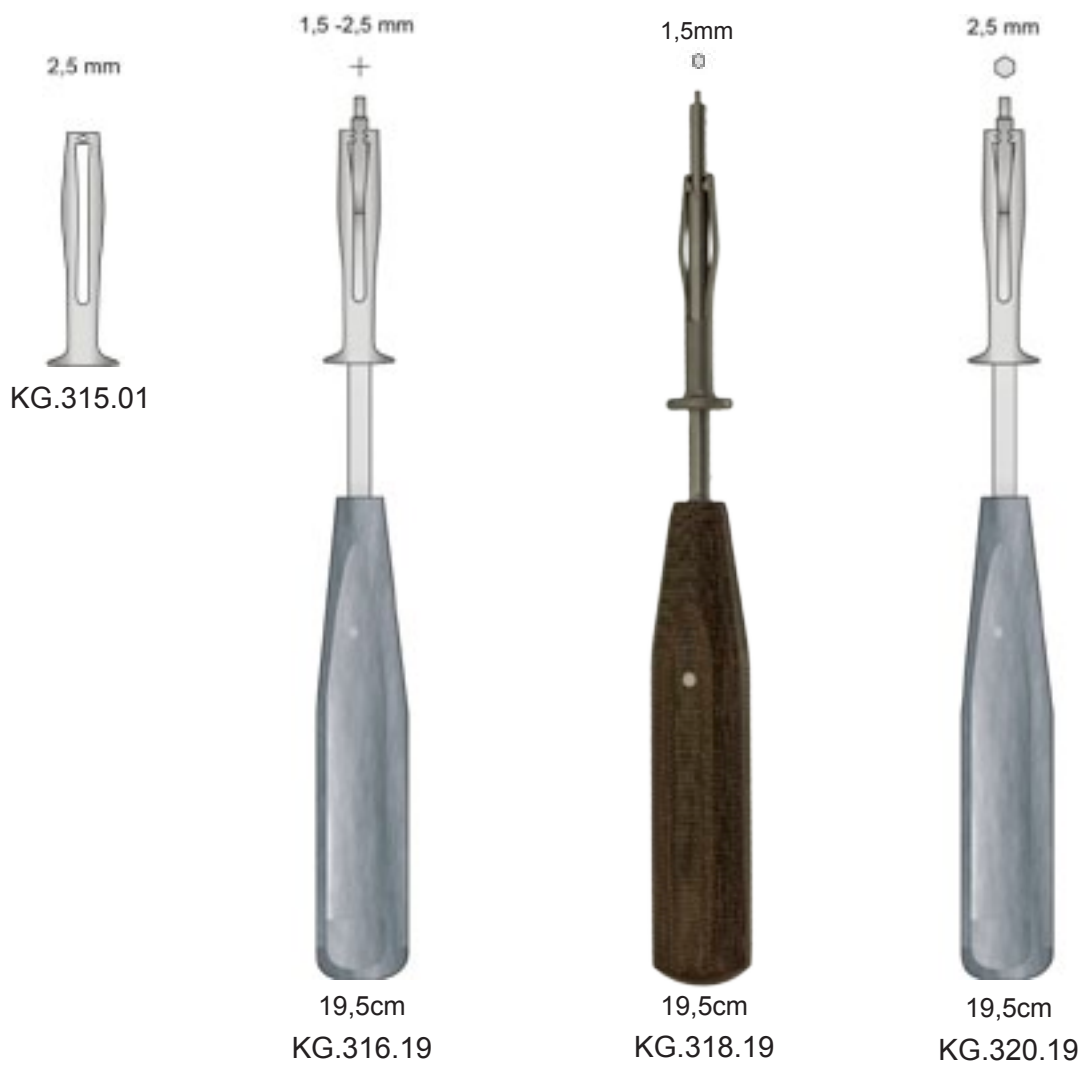



16,5cm
KG.400.01



26,5cm
KG.400.04



1/2"



28cm
KG.400.06



1/2"

DRAHTSPANNZANGEN
WIRE TWISTER

TENSORES DE ALAMBRE
PINCES À TORSADER LE FIL
PINZA TORCIFILO

KH



Mayo-Haberisser



Mayo-Haberisser



Berry

ALICATES PLANOS
PINCES PLATES
TENAGILE PLATTE

FLACHZANGEN FLAT NOSE PLIERS

KH



Flachzange - kräftiges Modell

Article No.	Size
KH.226.17	17cm



Kombizange
mit Drahtschneider

Flachzange - kräftiges Modell

Article No.	Size
KH.226.18	18,0cm

FLACHZANGEN
FLAT NOSE PLIERS

ALICATES PLANOS
PINCES PLATES
TENAGILE PLATTE

KH



Flachzange

Article No.	Size
KH.260.14	14,0cm



Marburg

Article No.	Size
KH.262.01	14,0cm



KH.262.02



KH.262.03



Mit Hartmetalleinlage
with TC inserts
KH.262.06



Feststellzange

Article No.	Size
KH.262.18	18,0cm



Feststellzange

Article No.	Size
KH.262.24	24,0cm





Flachzange einstellbar
Flat pliers movable

Article No.	Size
KH.264.20	20.0cm



Mit Hartmetalleinsätzen

With Tungsten Carbide inserts

Avec mors en métal dur
Con puntas de metal duro
Con punte in metallo duro

Für Draht bis 1,2mm hart und 2,0mm weich

For wire to 1,2mm hard and 2,0mm soft

Flachzange mit Drahtschneider

Article No.	Size
KH.265.22	22,0cm

FLACHZANGEN
FLAT NOSE PLIERS

ALICATES PLANOS
PINCES PLATES
TENAGILE PLATTE

KH



Mit Schneider
With cutter



Flachzange

Article No.	Size
KH.267.16	16,5cm

Flachzange

Article No.	Size
KH.267.17	17,5cm



Langes Maulteil
mit Schneider
Long Jaw parts
with cutter



Sehr langes Maulteil
mit Schneider
Very long Jaw parts
with cutter

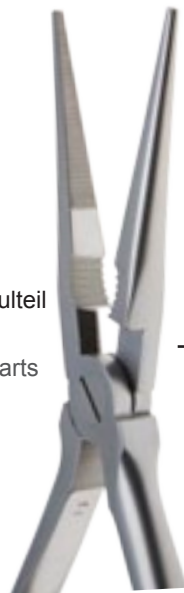

Flachzange

Article No.	Size
KH.267.20	20,0cm

FÓRCEPS PARA EXTRAER ALAMBRE
 PINCES PLATES
 TENAGLIE PIATTE

DRAHTFASSZANGEN WIRE HOLDING FORCEPS

KH



4,0mm
 KH.240.02 6,0mm
 KH.240.06

Flachzange übersetzt 2,0mm

Article No.	Size
KH.240.01	18,0cm



Mit Hartmetall-
 einsätzen

With Tungsten
 Carbide inserts

Avec mors en métal dur
 Con puntas de metal duro
 Con punte in metallo duro



Extensionszange HM

Article No.	Size
KH.241.44	14,0cm



Extensionszange

Article No.	Size
KH.241.14	14,0cm



4,0mm
 KH.244.04

6,0mm
 KH.244.06

Rund-Rund
 KH.244.18

Flachzange übersetzt 2,5mm

Article No.	Size
KH.244.02	18,0cm

EXTRAKTIONSZANGEN FÜR BOHRDRÄHTE

WIRE EXTRACTION

FÓRCEPS PARA EXTRAER ALAMBRE
PINCES PLATES
PINZE PER ESTRAZIONE FILI MATALLICI

KH



Flachzange - gerieft Backen

Article No.	Size
KH.270.01	17,0cm



Flachzange - Längs- u. Querrillen

Article No.	Size
KH.270.02	17,0cm



Mit Hartmetalleinsätzen

With Tungsten Carbide inserts

Flachzange mit HM

Article No.	Size
KH.275.19	19,0cm

Flachzange

Article No.	Size
KH.274.19	19,0cm



Extraktionszange

Article No.	Size
KH.280.13	13,0cm



Extraktionszange

Article No.	Size
KH.280.18	18,0cm

FÓRCEPS PARA CORTAR ALAMBRE
PINCESÀ COUPER LE FIL
TRONCHESI PER FILI METALLICI

DRAHTSCHNEIDEZANGEN
WIRE CUTTERS

KH



1:1

Diamant Kopfschneider

Article No.	Size
KH.310.16	16,0cm

HM DRAHTSCHNEIDEZANGEN TC WIRE CUTTERS

FÓRCEPS PARA CORTAR ALAMBRE
PINCESÀ COUPER LE FIL
TRONCHESI PER FILI METALLICI

KH



Drahtkneifzange HM

Article No.	Size
KH.312.18	18,0cm
KH.312.20	20,0cm

Mit Hartmetall-
einsätzen

With Tungsten
Carbid inserts

Avec mors en métal dur
Con puntas de metal duro
Con punte in metallo duro



Plattenschneidezange

Article No.	Size
KH.322.24	24,0cm

FÓRCEPS PARA CORTAR ALAMBRE
PINCESÀ COUPER LE FIL
TRONCHESI PER FILI METALLICI

HM DRAHTSCHNEIDEZANGEN TC WIRE CUTTERS

KH

Mit Hartmetall-
einsätzen

*With Tungsten
Carbid inserts*

Avec mors en métal dur
Con puntas de metal duro
Con punte in metallo duro



Drahtschneidezange 1,7mm

Article No.	Size
KH.315.16	16,0cm
KH.315.18	18,0cm



Drahtschneidezange 2,2mm

Article No.	Size
KH.315.23	23,0cm

HM DRAHTSCHNEIDEZANGEN
TC WIRE CUTTERS

FÓRCEPS PARA CORTAR ALAMBRE
 PINCESÀ COUPER LE FIL
 TRONCHESI PER FILI METALLICI

KH



Drahtschneidezange 1,5mm

Article No.	Size
KH.316.18	18,0cm

Mit Hartmetall-
einsätzen

*With Tungsten
Carbid inserts*

Avec mors en métal dur
 Con puntas de metal duro
 Con punte in metallo duro



Seitenschneider 2,2mm

Article No.	Size
KH.316.23	23,0cm



Kopfschneider 2,5mm

Article No.	Size
KH.318.22	22,0cm

Mit Hartmetall-
einsätzen

*With Tungsten
Carbid inserts*

Avec mors en métal dur
Con puntas de metal duro
Con punte in metallo duro



Kopfschneider 1,5mm

Article No.	Size
KH.320.15	15,0cm



Kopf- und Seitenschneider 1,7mm

Article No.	Size
KH.340.18	18,0cm

HM DRAHTSCHNEIDEZANGEN

TC WIRE CUTTERS

FÓRCEPS PARA CORTAR ALAMBRE
 PINCESÀ COUPER LE FIL
 TRONCHESI PER FILI METALLICI

KH



Waldsachs
 Klammer- und Bügelbiege

Article No.	Size
KH.258.16	16,0cm



Weicher Draht
 bis 0,6mm
 Harter draht
 bis 0,3mm

Angle
 Drahtschneidezange HM

Article No.	Size
KH.263.13	13,0cm



Drahtschneidezange 0,7mm

Article No.	Size
KH.372.12	12,5cm



Drahtschneidezange mittel

Article No.	Size
KH.374.13	13,0cm



Drahtschneidezange 1,0mm

Article No.	Size
KH.376.15	15,0cm



Drahtschneidezange HM 1,0mm

Article No.	Size
KH.377.15	15,0cm



Kopfschneider

Article No.	Size
KH.378.14	14,5cm



Bolzenschneider 6mm

Article No.	Size
KH.350.47	47,0cm



Ersatzbacken
KH.350.99

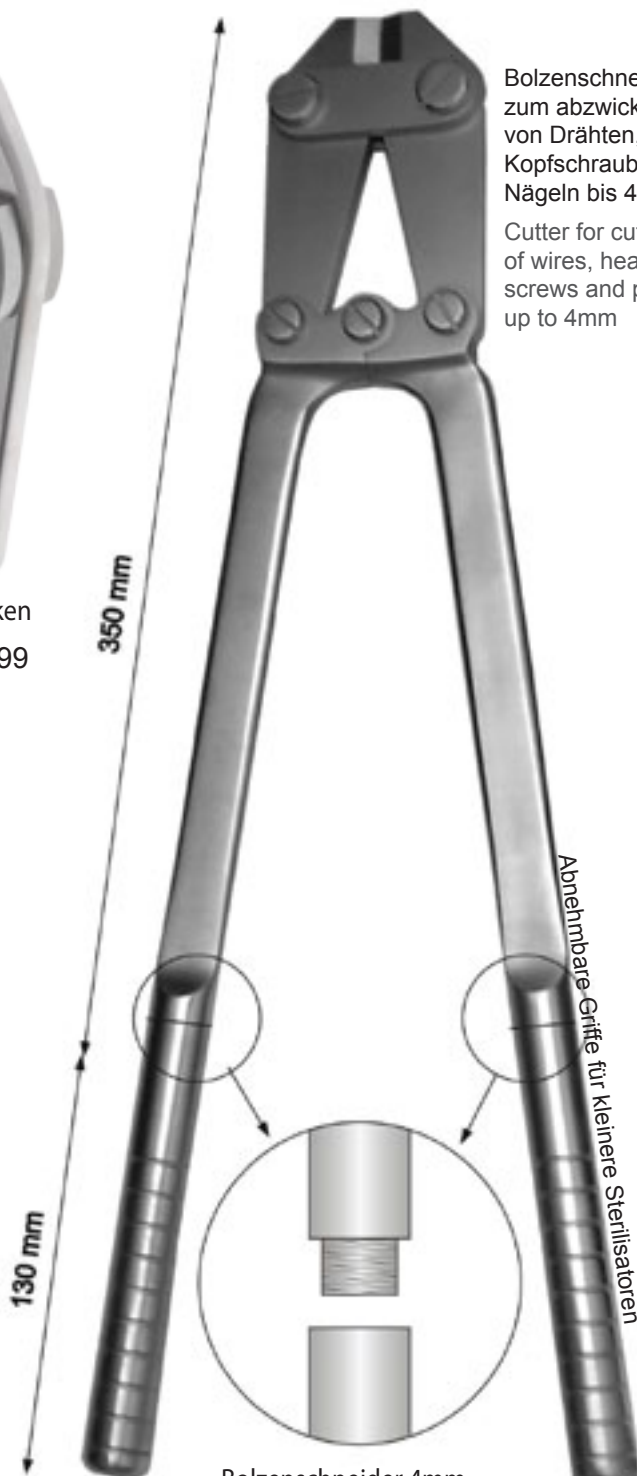

Bolzenschneider zum abwickeln von Drähten, Kopfschrauben & Nägeln bis 4mm
Cutter for cutting of wires, head screws and pins up to 4mm

Bolzenschneider 4mm mit abnehmbaren Griffen

Article No.	Size
KH.352.48	48,0cm

BOLZENSCHNEIDER
PIN CUTTERS / WIRE CUTTERS

FÓRCEPS PARA CORTAR ALAMBRE Y AGUJAS
PINCES À COUPER LE FIL
TENAGLIE TAGLIAFIL

KH

Kopfschneider zum
abzwicken von Drähten,
Kopfschrauben und
Nägeln bis 5mm

Cutter for cutting of
wires, head screws and
pins up to 5mm



Bolzenschneider 5mm
Kopfschneidend

Article No.	Size
KH.354.38	38,0cm

Bolzenschneider zum Schneiden von Kirschner Drähten, Steinman Nägel und Schrauben bis 6mm
Cutter for cutting of Kirschner wires, Steinman Pins and Screws up to 6mm diam.



Bolzenschneider 6mm

Article No.	Size
KH.356.45	45,0mm



Bolzenschneider 6mm

Article No.	Size
KH.356.56	56,0mm

KRAMPONZANGEN UNIVERSAL
KRAMPON FORCEPS

FÓRCEPS PARA CORTAR ALAMBRE
PINCESÀ COUPER LE FIL
TRONCHESI PER FILI METALLICI

KH

Für harten Draht bis 1mm
For hard wire 1mm
Para alambres duro 1mm
Per filio duro 1mm



Kramponzange

Article No.	Size
KH.360.15	15,0cm



Kramponzange flach

Article No.	Size
KH.362.15	15,0cm

CIZALLAS PARA CORTAR ALAMBRE
 CISEAUX POUR FIL
 FORBICI PER FILI

DRAHTSCHEREN WIRE CUTTING SCISSORS

KH

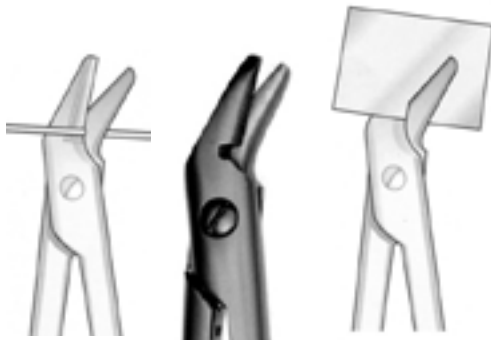

Universal Drahtschere
 Eine Seite gezahnt

Article No.	Size
KH.547.12	12,0cm

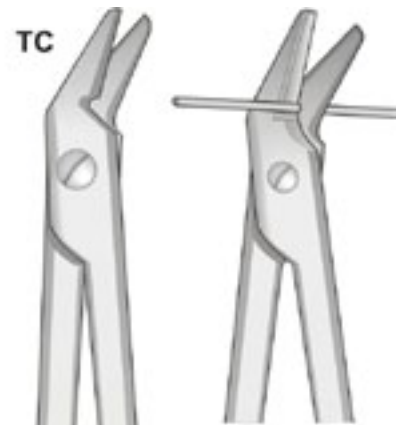
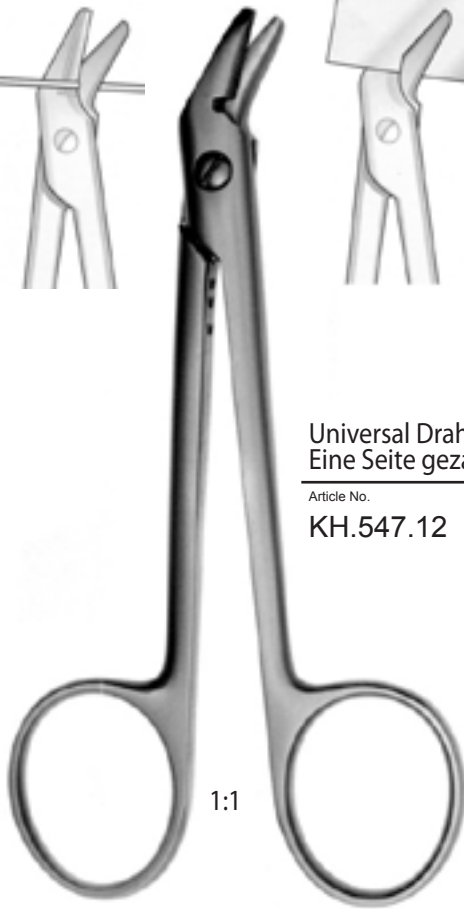

Universal Drahtschere
 HM

Article No.	Size
KH.865.12	12,0cm

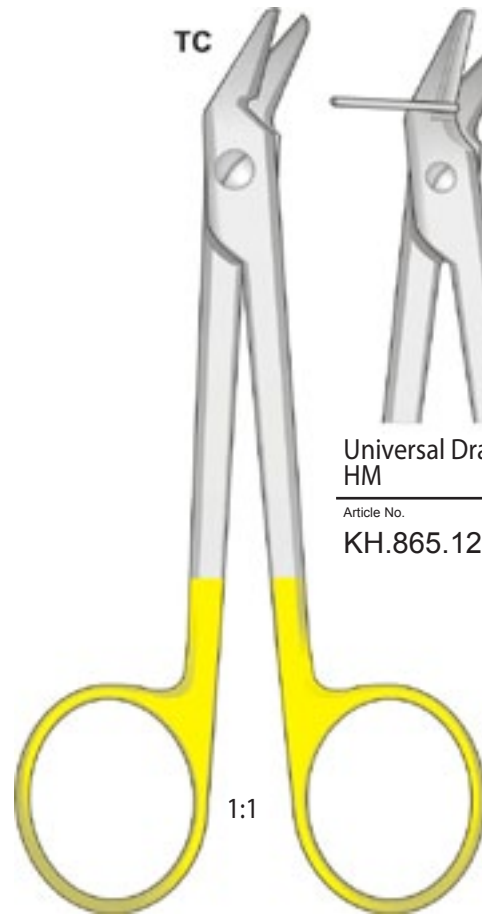

Smith Drahtschere HM
 Eine Seite gezahnt

Article No.	Size
KH.392.16	16,0cm



Smith Drahtschere HM
 Mit Drahtkerbe

Article No.	Size
KH.394.16	16,0cm



CERCLAGEDRAHT SOFT WIRES

HILO PARA HUESOS
FIL POUR CERCLAGE
FILO PER OSSA

KH



Weich
Soft
blado
melléable
malleabile

Ring mit 10m
coils of 10m
en rolls de 10m
en rouleaux de 10m

Knochendraht 1.4441

Article No.	Size
KH.600.02	0,2mm
KH.600.03	0,3mm
KH.600.04	0,4mm
KH.600.05	0,5mm
KH.600.06	0,6mm
KH.600.07	0,7mm
KH.600.08	0,8mm
KH.600.09	0,9mm
KH.600.10	1,0mm
KH.600.12	1,2mm
KH.600.15	1,5mm
KH.600.18	1,8mm
KH.600.20	2,0mm

Knochendraht REINTITAN

Article No.	Size
KH.600.58	0,8mm
KH.600.60	1,0mm
KH.600.62	1,2mm

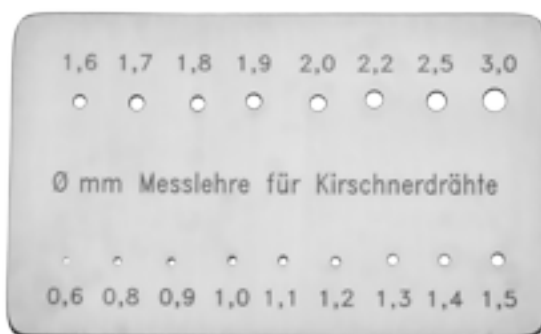

Meßlehre für Kirschnerdrähte

Article No.	Size
KH.600.99	0,6 - 3,0



Stahlmeßstab

Article No.	Size
KH.601.20	20,0cm
KH.601.30	30,0cm
KH.601.40	40,0cm
KH.601.50	50,0cm

BIEGEINSTRUMENT
BENDING INSTRUMENT

KH



Biegeinstrument

Article No.	Size
KH.590.12	12,0cm



Biegeinstrument
für Kirschnerdrähte

Article No.	Size
KH.592.30	30,0cm

DRAHTSÄGEN

WIRE SAWS

KH



Olivercra Drahtsägen

Article No.	Size
KH.603.30	30,0cm
KH.603.40	40,0cm
KH.603.50	50,0cm
KH.603.60	60,0cm
KH.603.70	70,0cm

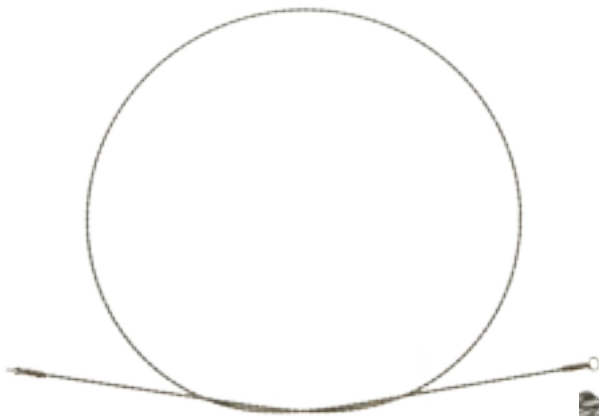

Gigli Drahtsägen

Article No.	Size
KH.604.30	30,0cm
KH.604.40	40,0cm
KH.604.50	50,0cm
KH.604.60	60,0cm
KH.604.70	70,0cm



Hakengriff
für Drahtsägen

Article No.
KH.650.01

DRAHTUMFÜHRUNGSNADELN
CERCLAGE INSTRUMENTS

AIGUILLES PASS-FILS
AGHI PASSAFILLI

KH



Demel



30,5cm
KH.700.01



28,5cm
KH.700.02



27,5cm
KH.700.03



22,5cm
KH.702.22



45mm
24cm
KH.702.24



80mm
27cm
KH.702.27





Drahtumführung
23,5cm



45mm
KH.704.45



70mm
KH.704.70

DRAHTSPANNER
WIRE TIGHTENING INSTRUMENTS

INSTRUMENTOS TENSOSES DE ALAMBRE
TENDEURS-FIL
STRUMENTI TENDIFILO METALLICO

KH



Demel
27cm
KH.718.28



Loute
22cm
KH.720.21



Für Erwachsene
for adults
para adultos
pour adultes
per adulti

Bleihand

Article No.	Size
KH.960.02	Erwachsen



Für Kinder
for children
para ninos
pour enfants
per bambini

Bleihand

Article No.	Size
KH.960.01	Kind

SCHRÄNKHEBEL BENDING IRONS FOR BONE PLATES

INSTRUMENTS POUR COURBER LES PLAQUES
INSTRUMENTOS PARA DOBLAR PLACAS
STRUMENTI PER PIEGARE PLACCHE

KJ

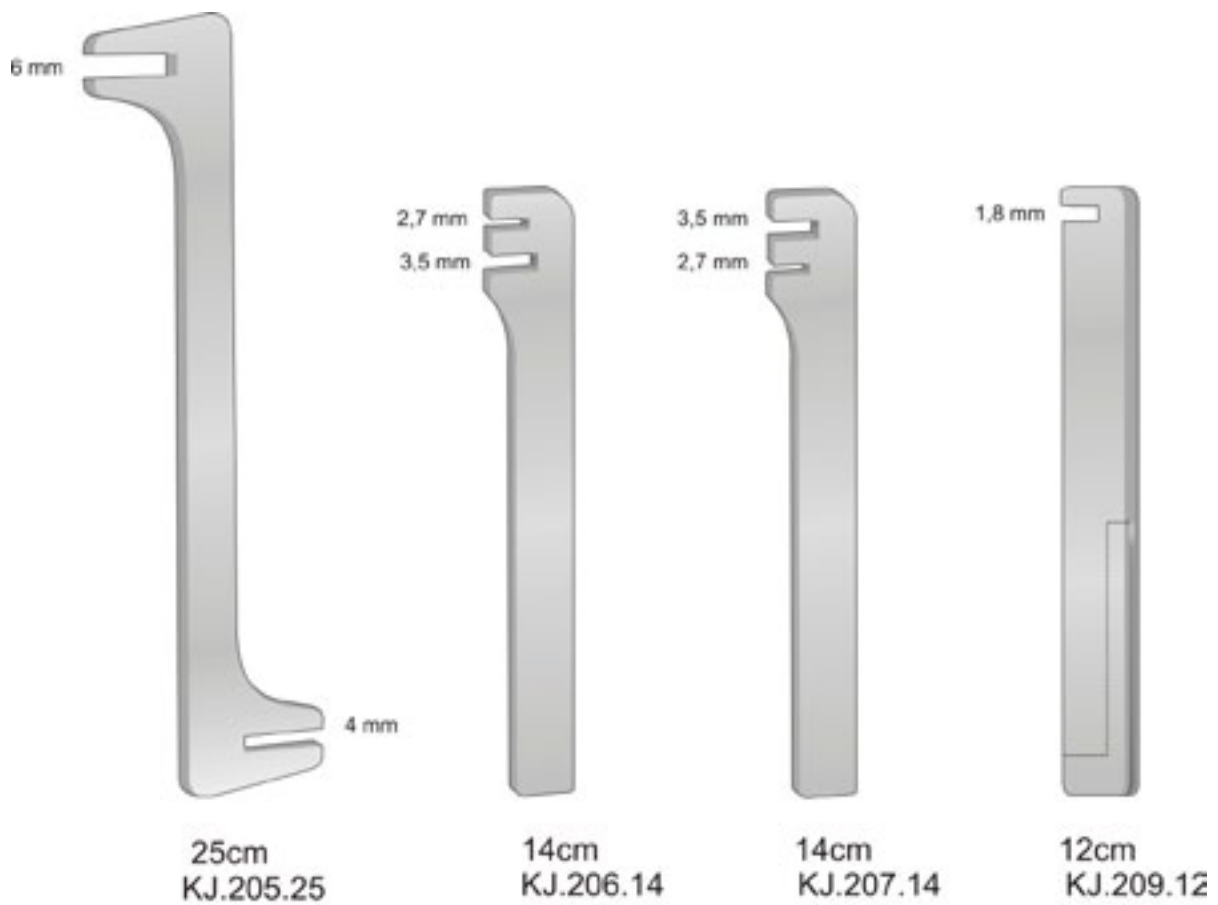

Hautstift fein rostfrei
KJ.900.00

PLATTENBIEGEINSTRUMENTE FORCEPS FOR PLATTES-BENDING PRESS

KJ

Für Platten bis 1,6mm
For plates up to 1,6mm



20cm
KJ.600.20

Für Platten bis 3mm
For plates up to 3mm



24cm
KJ.600.24



Biegeapparat zum Biegen von Knochenplatten
bis 6mm Dicke. Der untere Backen ist herausnehmbar.
Komplett aus rostfreiem Material gefertigt

KJ.610.00

MH



Standzylinder
 50x100mm
 MH.302.10

50x130mm
 MH.302.13

50x175mm
 MH.302.17

75x100mm
 MH.302.40

75x130mm
 MH.302.43

75x175mm
 MH.302.47

Mit festem Fuß



Standzylinder
 50x100mm
 MH.303.10

50x130mm
 MH.303.13

50x175mm
 MH.303.17



Nierenschalen

MH.600.17 = 170mm

MH.600.20 = 200mm

MH.600.25 = 250mm

MH.600.27 = 275mm



Laborschale

MH.660.04 = 40x19mm

MH.660.06 = 60x30mm

MH.660.08 = 85x41mm

MH.660.11 = 115x56mm

MH.660.12 = 130x55mm

MH.660.14 = 150x65mm

Mit Ausguß
 with spout



Lösungsschale

MH.650.04 = 4,5cm 0,03l

MH.650.06 = 6,0cm 0,10l

MH.650.08 = 8,0cm 0,15l

MH.650.10 = 10,0cm 0,25l

MH.650.12 = 12,0cm 0,5l

MH.650.16 = 16,0cm 1l

MH.650.20 = 20,0cm 2l

MH.650.24 = 24,0cm 4l



**Lösungsschale
breiter Rand**



8cm x 3,5cm	MH.665.08
9cm x 5,5cm	MH.665.09
10cm x 6,5cm	MH.665.10
12cm x 7,0cm	MH.665.12

Watte- und Tupferbehälter



		
Durchmesser diameter	Höhe height	
8,5cm	8,5cm	MH.670.09
10cm	10cm	MH.670.10
12cm	12cm	MH.670.12
15cm	15cm	MH.670.15



Stechbecken mit Deckel

Article No.	Size
MK.102.31	31cm



Stechbecken ohne Deckel

Article No.	Size
MK.105.24	32x24cm
MK.105.29	37x29cm



Article No.	For	Article No.	For	Article No.	For
MK.106.20	Female	MK.106.15	Urinal	MK.106.10	Male

NADEL STERILISIERKÄSTCHEN
STERILIZATION AND CONSERVATION

ESTERILIZACIÓN Y CONSERVACIÓN
 BOITES POUR STÉRILISER DES AIGUILLES
 SCATOLE PER STERILIZZARE AGHI

MH



MH.810.65

65mm
 komplett
 Complete
 completa
 complète
 completa



MH.811.65

62mm
 Innendose allein
 insert only
 caja interior suelta
 boîte interior suelta
 Scatola interiore sola

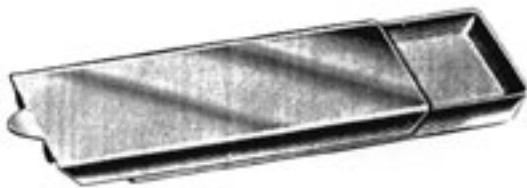

MH.800.50 = 50 x 25 x 4,5mm
 MH.800.65 = 65 x 42 x 8mm
 MH.800.75 = 75 x 25 x 4,5mm



MH.802.50 = 50 x 25 x 4,5mm
 MH.802.65 = 65 x 42 x 8mm
 MH.802.75 = 75 x 25 x 4,5mm



200 x 120 x 15mm
MH.815.20



150 x 95 x 13mm
MH.818.15

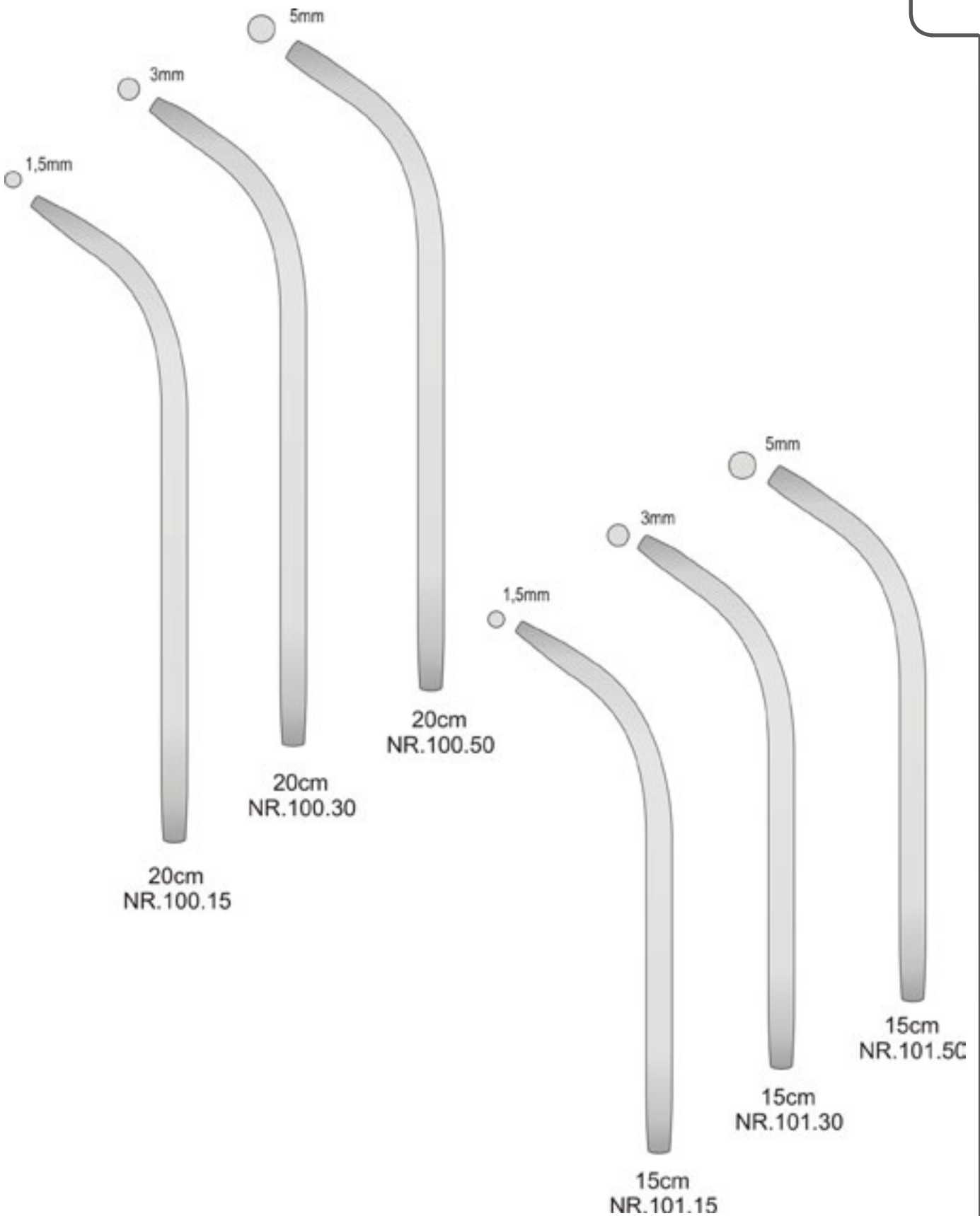

MEDE TECHNIK

Rudolf-Diesel-Str. 13
78576 Emmingen
Germany

Tel: +49 (0)7465 893
Fax: +49 (0)7465 2262

info@mede.de
www.mede.de

DIN EN ISO 13485 zertifiziert / certified.

Nachdruck, auch auszugsweise, nicht gestattet.
Reprinting even partially is not allowed.